

# BABY MOOV



COLLECTION  
2023-2024



# Here at Babymoov, we're already thinking about tomorrow.

Babymoov's got everything covered: from meals to naps, from travel to restless nights, via baby care, comfort, and maternity.

Whatever you're experiencing, we are by your side to offer your baby the very best, whilst taking care of the planet too.

Together with parents and childcare experts, we invent ingenious products that we call « solutions designed for life ».



## THREE WORDS THAT DEFINE THE BABYMOOV BRAND:

# 1.

### Expertise

Capitalising on over 25 years of expertise to develop solutions that are both reliable and genuinely useful.

# 2.

### Premium

High-quality solutions made from robust, long-lasting materials. Beautiful materials and ingenious designs that complement modern interiors.

# 3.

### Durability

Quality for now and long into the future. We take care of today's babies and tomorrow's parents with products designed to last.



Becoming parents heralds the beginning of a fabulous adventure, starting a whole new phase. This new chapter in your life is shaped by your beliefs, environment, lifestyle and needs.

Babymoov's aim is to offer parents the very best solutions for this new and exciting adventure, supporting you in your journey through parenthood. We will always be **ON THE MOVE** with you.

Just like your children, we grow with you, and we are committed to constantly bringing you innovative, eco-friendly, ingenious and durable products so you can enjoy this new life to the full.

Because we want the very best, for you and the planet. Because we work together to design solutions for life, your life.

**BABYMOOV**  
**Solutions designed for life**



## Because the actions we take today determine the future of our children,

Babymoov is committed to reducing its environmental footprint through the **GreenMoov** approach, and to taking action to promote a better social and societal policy.

Babymoov has always offered a lifetime Warranty on its electronic products to ensure their durability. This has also given rise to our eco-design approach, making the majority of our products repairable and thus ensuring they have a long, and even a second life!

The choice of materials plays a decisive role in our innovation strategy: organically sourced, recycled and/or recyclable raw materials, regional manufacturing... to help reduce the carbon footprint of our business.

Together, let's change our consumption habits step by step for a greener future.

To minimise our ecological footprint, we have set ourselves targets that will have a real impact on our planet over the next five years:

To reduce our carbon intensity by

**20%**

by 2026

**70%**

of our products to be eco-designed by 2026

To reduce the carbon footprint of each of our products by

**20%**

by 2026

## Our mission:

To imagine, co-create and design durable childcare products.



Because our primary objective is to give parents total peace of mind when they choose a Babymoov product, we have very high standards of quality and durability.

WITH A...

## Lifetime warranty

On all the products we are able to « repair »

BABY MONITORS  
FOOD PREP  
MEDIUM CHILDCARE PRODUCTS  
BABYCARE KITS

## 10-year warranty

On all our mattresses to offer long-term support to parents and ensure their babies sleep soundly.

## 2-year warranty

On all our other products, covered by the legal Guarantee of conformity.

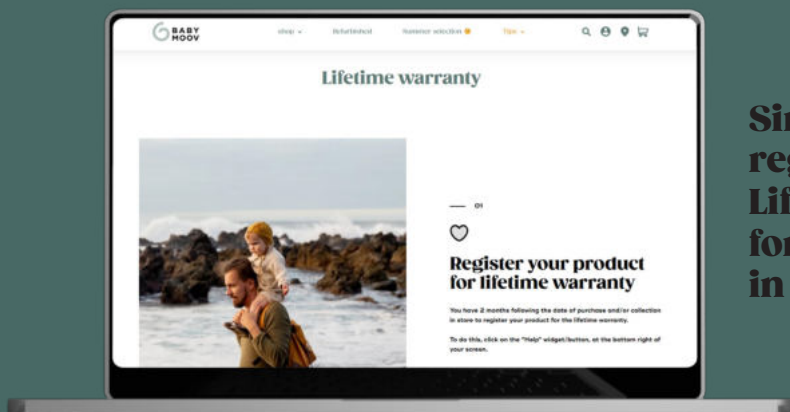

**Simplify registration of the Lifetime Warranty for your customers in two quick steps**

- 1- Go to the [babymoov.co.uk](https://www.babymoov.co.uk) website within 2 months of purchase.
- 2- Register their product using their proof of purchase, product reference and batch number.

**Because at Babymoov we like to combine simplicity and efficiency, we've decided to make your life easier!**



**We provide you with a range of tools to help you be even more ON THE MOOV in store and/or online!**



Ready-to-post content for your **SOCIAL MEDIA**, to help you connect with your communities.



Support with **MERCHANDISING** and **E-MERCHANDISING**, to challenge/optimize your websites and/or store displays.



**A LOCAL CUSTOMER SERVICE**, always ready to listen and respond to all your customers' requests, and to support them every step of the way.

# Sum- mary

## Pregnancy

- Maternity pillows
- Sleep belts

## Feeding

- Food processors
- Containers
- Mealtime
- Bottle preparation

## Comfort

- Baby comfort
- Mattresses
- Bouncers
- Swings

## Well Being

- Humidifiers
- Nightlights

## Safety

- Audio babymonitors
- Video babymonitors
- Motorised video babymonitors

## Care

- Grooming sets
- Changing mats
- Bathtubs

## Out & About

- Summer protection
- Travel cots
- Changing bags
- Baby carriers
- Walkers

## Icon Keys



Pegbordable headercard pack



Pegbordable blister pack



Pegbordable bag pack



Cardboard box



Tag

New

New product

Top-Seller

Top seller

New colour

New colour



Lifetime warranty



10 year warranty



Eco-designed



Repairable



Local production



# Pregnancy range



Maternity pillows / sleep belts



# Babymoov, solutions designed for a new life.

We designed our range of maternity pillows with the assistance of a group of experts in the field, namely mothers-to-be and midwives.



**Be comfy**



**Be premium**

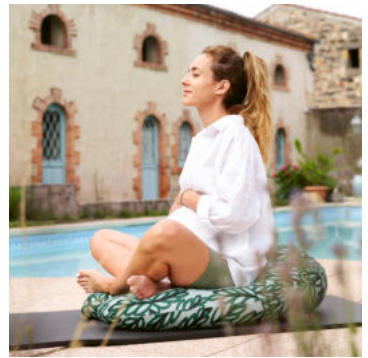

**Be trendy**

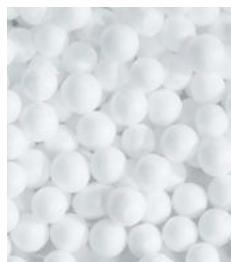
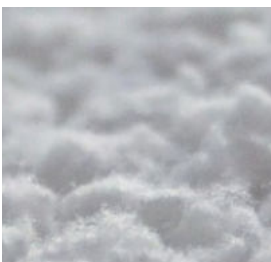

Design, ergonomics, adaptability, local manufacturing and a choice of responsible materials - our solutions, which are often patented, combine all the criteria to ensure optimum comfort during and after pregnancy.





# B.Love Maternity pillow

A MUST-HAVE CUSHION FOR UNRIVALLED COMFORT

### Earth Terracotta

SKU **A062039**



3 661276 180239

### Vegetal Green

SKU **A062027**



3 661276 179684

### Mineral Grey

SKU **A062028**



3 661276 179691

### Wind Blue

SKU **A062029**



3 661276 179707



THE B.Love CONCEPT

- Cover made from soft, GOTS-certified organic cotton, super soft and stretchy
- OEKO-TEX® certified cushion
- Supplied in a reusable bag made from recycled materials (plastic and fabric offcuts)
- Supports the neck, back, legs and tummy of mums-to-be
- Stays in place during feeding, thanks to an ingenious fastening system (button)
- Soft and adjustable for maximum comfort when breastfeeding or bottle-feeding
- Very fine, Toxproof-certified (non-toxic) microbeads make the cushion silent and lightweight
- Refillable (bag of microbeads sold separately)

**COMPOSITION:**

Cover: 95% Organic Cotton, 5% Elastane  
 Inner cover: 97% Polyester, 3% Elastane  
 Filling: expanded Polystyrene microbeads

**MAINTENANCE:**

Cover is machine washable at 30°C  
 Pillow is hand washable only  
 Do not tumble dry

**PRODUCT SIZE (L x W x H):**

Unfolded: 190 cm  
 Folded: 85 x 26 x 15 cm



New

## Microbeads Refill



SKU **A062033**



3 661276 179745

**COMPOSITION:**

Expanded Polystyrene microbeads



“ The **maternity pillow** combines support and relaxation for unparalleled comfort, thanks to its ergonomic shape and ultra-fine and silent microbeads. During baby’s meals, an attachment system keeps the cushion in place, allowing for hands-free use. ”



**CHARLINE SPEZIALE**  
 Babymoov Product Marketing Manager

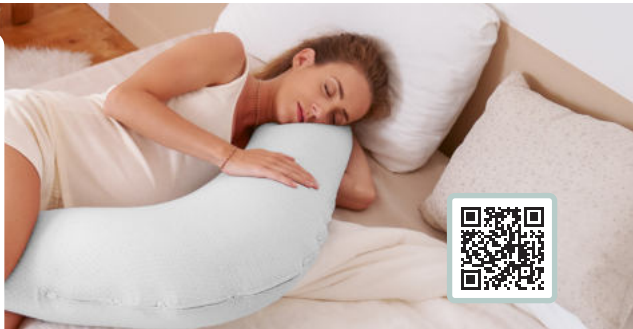

Top-Seller

PREGNANCY



# B.Love Maternity pillow + cover bundle

A MUST-HAVE CUSHION FOR UNRIVALLED COMFORT



Earth Off White +  
Terracotta  
A062025



3 661276 179660



Vegetal Blue +  
Wind Blue  
A062026



3 661276 179677

THE B.LOVE  
CONCEPT

- Cover made from soft, GOTS-certified organic cotton, super soft and stretchy
- OEKO-TEX® certified cushion
- Supplied in a reusable bag made from recycled materials (plastic and fabric offcuts)
- Includes 1 pregnancy pillow and 2 covers
- Supports the neck, back, legs and tummy of mums-to-be
- Stays in place during feeding, thanks to an ingenious fastening system (button)
- Soft and adjustable for maximum comfort when breastfeeding or bottle-feeding
- Very fine, Toxproof-certified (non-toxic) microbeads make the cushion silent and lightweight
- Refillable (bag of microbeads sold separately)



**COMPOSITION:**

Cover: 95% Organic Cotton, 5% Elastane  
Inner cover: 97% Polyester, 3% Elastane  
Filling: expanded Polystyrene microbeads

**MAINTENANCE:**

Cover is machine washable at 30°C  
Pillow is hand washable only  
Do not tumble dry

**PRODUCT SIZE (L x W x H):**

Unfolded: 190 cm  
Folded: 85 x 26 x 15 cm



# Solutions designed for a new life



Top-Seller

PREGNANCY

# B.Love 2-in-1 pillow

AN INGENUOUS AND ADAPTABLE MULTI-SHAPE CUSHION

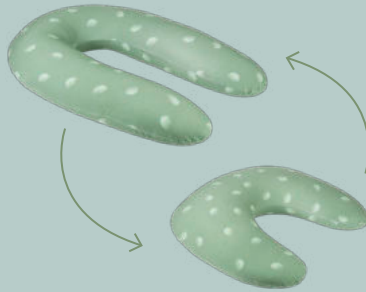
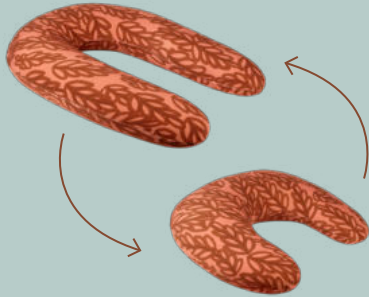

New colour

### Vegetal Terracotta

SKU **A062031**



3 661276 179721

### Wind Green

SKU **A062030**



3 661276 179714

### Petals Off White

SKU **A062042**



3 661276 184541

THE B.LOVE  
CONCEPT

- Cover made from soft, GOTS-certified organic cotton, super soft and stretchy
- OEKO-TEX® certified cushion
- Supplied in a reusable bag made from recycled materials (plastic and fabric offcuts)
- Unique, innovative and adaptable: converts from a maternity cushion into a compact breastfeeding cushion
- As a maternity cushion: supports the neck, back, legs and tummy of mums-to-be
- As a compact cushion: supports the baby at the right height when breastfeeding or bottle-feeding
- Very fine, Toxproof-certified (non-toxic) microbeads make the cushion silent and lightweight
- Refillable (bag of microbeads sold separately)



#### COMPOSITION:

Cover: 95% Organic Cotton, 5% Elastane  
 Inner cover: 97% Polyester, 3% Elastane  
 Filling: expanded Polystyrene microbeads

#### MAINTENANCE:

Cover Machine-washable at 30°C  
 Pillow is hand washable only  
 Do not tumble dry

#### PRODUCT SIZE (W x D x H):

U Shape: Unfolded: 175 cm / Folded: 75 x 26 x 15 cm  
 C Shape: Unfolded: 160 cm / Folded: 50 x 26 x 15 cm



“

The **2-in-1 cushion** features a revolutionary patented innovation for expectant parents. Ultra plush with its silent microbead filling, and thanks to its clever and easy transfer system, it is now possible to have 2 cushions in 1 for customized relaxation.”



**CÉLIA GRIGNON**

Babymoov General Manager of Innovation & Marketing



New

# B.Love Feeding pillow

EXPERT

LARGE  
FRONT SPACE  
FOR BABY'S  
COMFORT

PREMIUM

DENSE AND  
COMFORTABLE  
PADDING

~  
ORGANIC  
COTTON  
COVER

DURABLE

REUSABLE  
TRANSPORT  
BAG MADE FROM  
RECYCLED  
MATERIALS



New

PREGNANCY



# B.Love

## Feeding pillow

THE COMPACT PILLOW FOR YOUR BABY'S FIRST FEEDS



Mineral Grey

SKU **A062035**



3 661276 179769

Vegetal Terracotta

SKU **A062036**



3 661276 179776

THE B.LOVE  
CONCEPT

- Cover made from soft, GOTS-certified organic cotton, super soft and stretchy
- OEKO-TEX® certified cushion
- Supplied in a reusable bag made from recycled materials (plastic and fabric offcuts)
- Keeps baby at an ideal height during breastfeeding or bottle feeding
- Large front space for baby's comfort and compact design with good support for the parent
- Premium dense and comfortable padding for optimal long-lasting comfort
- Compressed compact carrying bag for space-saving



**COMPOSITION:**

Cover: 100% Organic Cotton

Inner cover: 100% Polyester

Filling: Polyester

**MAINTENANCE:**

Cover is machine washable at 40°C

Pillow is hand washable only

Do not tumble dry

**PRODUCT SIZE (W x D x H):**

60 x 40 x 25 cm



“

For all baby's mealtime moments, we have developed a « C »-shaped cushion specially designed to facilitate breastfeeding or bottle-feeding. Placed around the parent's waist, the **feeding pillow** provides a comfortable space for the baby and good support for the parent. ”



**ALEXANDRA MERMOUD**

*Babymoov Product Manager*



New

# B.Love XXL pillow

EXPERT

XXL SHAPE  
ADAPTED  
TO THE BODY  
OF THE  
MUM-TO-BE

PREMIUM

DENSE AND  
COMFORTABLE  
PADDING

~  
ORGANIC  
COTTON  
COVER

DURABLE

REUSABLE  
TRANSPORT  
BAG MADE FROM  
RECYCLED  
MATERIALS



New

PREGNANCY



# B.Love XXL pillow

THE MATERNITY PILLOW WITH XXL COMFORT FOR A GOOD NIGHT'S SLEEP



Mineral Grey  
SKU **A062037**



3 661276 179783



Wind Blue  
SKU **A062038**



3 661276 179790

THE B.LOVE  
CONCEPT

- Cover made from soft, GOTS-certified organic cotton, super soft and stretchy
- OEKO-TEX® certified cushion
- Supplied in a reusable bag made from recycled materials (plastic and fabric offcuts)
- Morphological, XXL shape adapted to the body of the mum-to-be
- Supports the neck, back, legs, and belly of the mum-to-be
- Clever: 2 flat parts on each side to free the arms
- Adaptable: 1 small cushion detaches for multiple uses
- Premium fiberfill for optimal support and comfort over time
- Compressed compact carrying bag for space-saving



**COMPOSITION:**

Cover: 100% Organic Cotton  
Inner cover: 100% Polyester  
Filling: Polyester

**MAINTENANCE:**

Cover is machine washable at 40°C  
Pillow is hand washable only  
Do not tumble dry

**PRODUCT SIZE (W x D x H):**

135 x 72 x 16 cm



“ Sleep is severely tested during pregnancy. To overcome all the discomforts that disrupt daily life and prevent quality sleep, we have designed the **XXL Pillow** to turn nights into true moments of relaxation and recovery for the body. ”



**ALEXANDRA MERMOUD**  
BabyMoov Product Manager

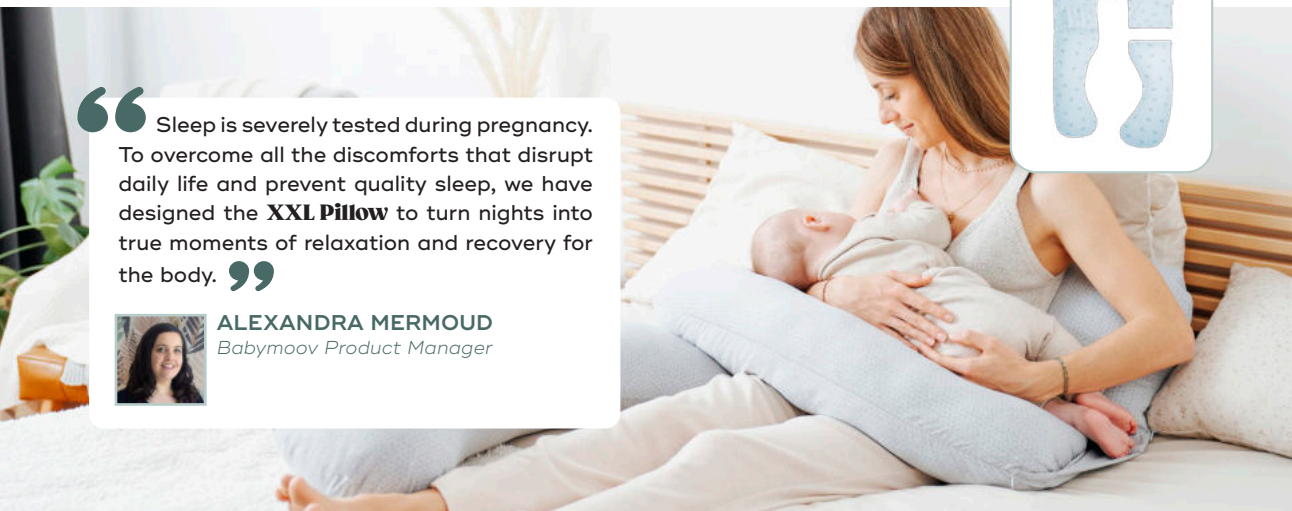



	Feeding	Maternity	XXL	2-in-1
	AO62035 AO62036	AO62025  + AO62026  + AO62027  + AO62028 AO62029 AO62039	AO62037 AO62038	AO62030 AO62031 AO62042
Patented				
Transport bag				
Local production				
FEATURES				
For pregnancy				
For breastfeeding				
Fastening system				
Convertible				
Refillable				
SIZE				
Unfolded	-	190 cm	-	U Shape: 175 cm C Shape: 160 cm
Folded	50 x 60 x 14,5 cm	85 x 26 x 15 cm	135 x 72 x 16 cm	U Shape: 75 x 26 x 15 cm C Shape: 50 x 26 x 15 cm
COMPOSITION				
Organic Cotton				
GOTS				
Oeko-Tex®				
Toxproof				
MAINTENANCE				
Removable cover				
Machine-washable				



# Dream Belt

## Sleep belt



BREVET DÉPOSÉ  
PATENT PENDING



THE VERY FIRST PREGNANCY SLEEPING BELT TO GUARANTEE A GREAT NIGHT'S SLEEP FOR MUMS-TO-BE

- For ensuring mums-to-be adopt an ideal position, for maximum comfort whilst sleeping
- 2 side panels made of memory foam to fill the gap between the tummy and the mattress
- Patented ergonomic belt, co-designed with midwives and mums-to-be
- Made from OEKO-TEX® certified stretch cotton fabric to adjust to each stage of pregnancy
- An adjustable belt with easy back fastening
- 2 sizes available to suit all body shapes



**S / M Size**  
SKU **A062010**

3 661276 154667

**L / XL Size**  
Ref. **A062000**

3 661276 147249

**COMPOSITION:**  
 Interior fabric: 95% Cotton, 5% Elastane  
 Centre front fabric: 65% Polyester, 27% Viscose, 8% Elastane  
 Interior fabric (around the foam): 100% Polyamide  
 Memory foam: 100% Polyurethane

**MAINTENANCE:**  
 Machine-washable at 30°C (except the foam from inside edges)

### Size guide

<b>S / M</b>	HIPS SIZE cm	84/88	88/92	92/94	
	Size UK	6	8	10	
<b>L / XL</b>	HIPS SIZE cm	94/96	96/100	104/108	108/112
	Size UK	12	14	16	18





# Feeding range

Food processors / containers / mealtime /  
bottle preparation

# Babymoov, solutions designed for a tasty life.



For over 25 years, with input from parents and experts in baby nutrition, we have been developing our range of intuitive, high-quality and sustainable solutions to support families from breastfeeding through to the introduction of solid foods.

**FRENCH  
DESIGN**

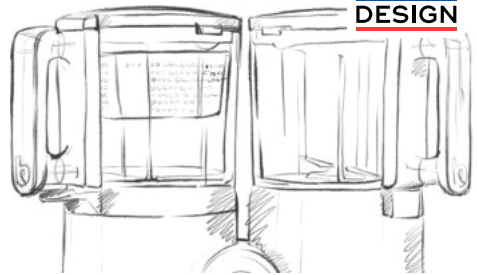

Silicone, glass, stainless steel, bio-sourced materials...

We place very high demands on the quality and durability of our products, all of which are certified by independent laboratories.

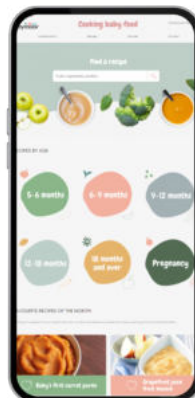

And don't forget **Cookingbabyfood**, our blog with hundreds of recipes and tips to guide parents through the different stages in the introduction of solid foods.



Solutions  
designed for  
a simple life



# Nutribaby One

## Food processor

THE USER-FRIENDLY FOR MAKING BABY LED-WEANING EASY



### THE Nutribaby CONCEPT

- Time saving: cooking and mixing unit works simultaneously
- Gentle steaming: preserves the nutrients and vitamins of food
- Possibility to cook ALL types of food: vegetables, fruits, meat, fish, cereals, rice, potatoes, eggs...
- Complete: juice recovery system to cook cereals, adjust texture and preserve nutrients
- 4-in-1: Steam cooks / Blends / Reheats / Defrosts
- Easy to use: one button to control it all
- Intuitive: 3 water levels (100 / 200 / 300 ml) depending on the quantity of food to be cooked
- Capacity: 2 litres (1 x 1,300 ml cooking unit + 1 x 700 ml blending unit)
- 1 steamer basket to divide up the cooking bowl and cook a wider variety of foods

SKU **AOO1133**

0 m+



3 661276172012

#### COMPOSITION:

Polypropylene, ABS, SAN, Tritan, BPA-free

#### MAINTENANCE:

All components, except the electrical part, are dishwasher-safe

#### POWER:

Warmer: 500W

#### POWER SUPPLY:

Operates on mains (plug included)

#### PRODUCT SIZE (W x D x H):

34,5 x 18 x 29,5 cm



“ With its large capacity, the ability to cook and blend at the same time and its 2 steamer baskets, the **Nutribaby One** is a must-have for batch cooking. ”



**CHARLINE SPEZIALE**

*Babymoov Product Marketing  
Manager*



# Solutions designed for a tasty life





# Nutribaby<sup>(+)</sup> Food processor

THE MUST-HAVE FOR VARIED AND TASTY MEALS



## Industrial Grey

SKU **A001124**



3 661276 148789



## Opal Green

SKU **A001136**



3 661276 179837



New  
colour

## Mineral Beige

SKU **A001135**



3 661276 179820

THE Nutribaby  
CONCEPT

- Time saving: cooking and mixing unit works simultaneously
- Gentle steaming: preserves the nutrients and vitamins of food
- Possibility to cook ALL types of food: vegetables, fruits, meat, fish, cereals, rice, potatoes, eggs...
- Complete: juice recovery system to cook cereals, adjust texture and preserve nutrients
- 6-in-1 (pre-programmed functions): Steam cooks / Blends / Defrosts / Sterilises and heats baby bottles / Heats baby food jars
- Easy to use: built-in control panel and timer (audible and visual alarm, automatic cut-off)
- Suitable for weaning onto solids: 3 blending speeds to adapt the texture of foods depending on baby's age
- Capacity: 2.2 litres (1 x 1,500 ml cooking unit + 1 x 700 ml blending unit)
- 2 separate steamer baskets to cook different foods perfectly without mixing them up
- The cooking unit operates independently
- Accessories included: one spatula

0 m+

### COMPOSITION:

Mixing bowl: SAN  
Cooking baskets: Tritan  
Trays and lids: Polypropylene  
BPA-free

### MAINTENANCE:

All components, except the electrical part, are dishwasher-safe

### POWER:

Warmer: 230V / 500W  
Blender 3 speeds: 230V / 400W

### POWER SUPPLY:

Operates on mains (plug included)

### PRODUCT SIZE (W x D x H):

39,5 x 25 x 31,5 cm



“ Like a smart and intuitive expert, the **Nutribaby<sup>(+)</sup>** ensures you can meet all the recommendations for your child's development: creating the right textures, and preparing healthy, varied and tasty meals. ”



**CÉLIA GIRAUDIE**  
Infant Nutritionist



# Solutions designed for a good life





# Nutribaby<sup>(+)</sup> XL

## Food processor

THE BRILLIANT FOR PREPARING LARGE QUANTITIES OF VARIED MEALS FOR BABY AND ALL THE FAMILY



SKU **AO01127**

0 m+



3 661276 161573

**COMPOSITION:**  
 Mixing bowl: SAN  
 Cooking baskets: Tritan  
 Trays and lids: Polypropylene  
 BPA-free

**MAINTENANCE:**  
 All components, except the electrical part, are dishwasher-safe

**POWER:**  
 Warmer: 230V / 500W  
 Blender 3 speeds: 230V / 400W

**POWER SUPPLY:**  
 Operates on mains (plug included)

**PRODUCT SIZE (W x D x H):**  
 39,5 x 25 x 36,5 cm



THE Nutribaby  
CONCEPT

- Time saving: cooking and mixing unit works simultaneously
- Gentle steaming: preserves the nutrients and vitamins of food
- Possibility to cook ALL types of food: vegetables, fruits, meat, fish, cereals, rice, potatoes, eggs...
- Complete: juice recovery system to cook cereals, adjust texture and preserve nutrients
- 6-in-1 (pre-programmed functions): Steam cooks / Blends / Defrosts / Sterilises and heats baby bottles / Heats baby food jars
- Easy to use: built-in control panel and timer (audible and visual alarm, automatic cut-off)
- Suitable for weaning onto solids: 3 blending speeds to adapt the texture of foods depending on baby's age
- XL capacity: 2.9 litres (1 x 2,200 ml cooking unit + 1 x 700 ml blending unit)
- 3 separate steamer baskets to cook different foods perfectly without mixing them up
- The cooking unit operates independently
- Accessories included: one spatula + a recipe book

“ The Nutribaby<sup>(+)</sup> XL is a food preparation system for parents wanting to cook more meals all in one go, or a full meal for the whole family. It is a great addition to the nutribaby range, with an exclusive and trendy colour. ”



**CHARLINE SPEZIALE**  
 Babymoov Product Marketing  
 Manager



# Solutions designed for a creative life





# Nutribaby Glass

## Food processor

THE ECO-FRIENDLY FOR MAKING HEALTHY, EASY MEALS



20%  
stainless  
steel

50%  
glass

THE Nutribaby  
CONCEPT

- Time saving: cooking and mixing unit works simultaneously
- Gentle steaming: preserves the nutrients and vitamins of food
- Possibility to cook ALL types of food: vegetables, fruits, meat, fish, cereals, rice, potatoes, eggs...
- Complete: juice recovery system to cook cereals, adjust texture and preserve nutrients
- Hygienic and sustainable: 2 glass cooking bowls and stainless steel basket
- 4-in-1: Steam cooks / Blends / Reheats / Defrosts
- Easy to use: one button to control it all
- Intuitive: 3 water levels (100 / 200 / 300 ml) depending on the quantity of food to be cooked
- Capacity: 1.5 litres (1 x 1,000 ml cooking unit + 1 x 500 ml blending unit)
- 1 steamer basket to divide up the cooking bowl and cook a wider variety of foods

### Green Forest

SKU **AOO1132**

0 m+



3 661276 171039

#### COMPOSITION:

50% glass,  
20% stainless Steel,  
30% Polypropylene  
BPA-free

#### MAINTENANCE:

All components, except  
the electrical part, are  
dishwasher-safe

#### POWER:

Warmer: 500W

#### POWER SUPPLY:

Operates on mains (plug  
included)

#### PRODUCT SIZE (W x D x H):

35,2 x 17,2 x 29,1 cm



“

The **Nutribaby Glass** is our first eco-friendly food processor, made of stainless steel and glass materials. It has all the essential features of the Nutribaby range. ”



**CÉLIA GRIGNON**

*Babymoov General Manager of Innovation & Marketing*



# #Nutribaby



Nutribaby One	Nutribaby(+)	Nutribaby(+) <sup>XL</sup>	Nutribaby Glass
AOO1133 ●	AOO1124 ● AOO1135 ● AOO1136 ●	AOO1127 ●	AOO1132 ●

## FUNCTIONS

Steamer	●	●	●	●
Blending	●	●	●	●
Baby bottle warmer	●	●	●	●
Baby jars warmer	●	●	●	●
Defrosting		●	●	
Sterilisation		●	●	

## CAPACITY

Cooking	1 300 ml	1 500 ml	2 250 ml	1 000 ml
Blending	700 ml	700 ml	700 ml	500 ml

## FEATURES

Glass / Steel				●
Steamer baskets	2	2	3	2
Juice recovery system	●	●	●	●
Blending speeds	x1	x3	x3	x1
Programmable		●	●	
Timer / Automatic cut-off		●	●	
Separable units		●	●	
Size	34,5 x 18 x 29,5 cm	39,5 x 25 x 31,5 cm	39,5 x 25 x 36,5 cm	35,2 x 17,2 x 29,1 cm



## Reusable Isy'Pouches

FOR TAKING BABY'S MEALS WITH YOU WHEREVER YOU GO



- Pack of 20 x 150 ml pouches
- Pouches can be re-used several times
- Airtight and robust for taking on-the-go
- Rewritable surface
- Open at the base: easy to fill and wash
- Perfect size for storing food and taking on-the-go
- Adaptable, can be used from the weaning stage through to snacks for older children
- Can be stored in the fridge or freezer

SKU **AOO4550**

0 m+



3 661276 179899

**COMPOSITION:**  
PET, Polyethylene  
BPA-free

**MAINTENANCE:**  
Dishwasher-safe

28 cm x6 7,5 cm  
12 cm

Top-Seller

## Eat's Isy Inox insulated box

A LARGE CAPACITY FOOD FLASK FOR  
TRIPS OUT WITH BABY

- Keep warm for 7 hours and cool for 5 hours thanks to the stainless steel double walls
- Airtight lid to keep food fresh and at the right temperature, and to prevent liquid spilling out
- Large capacity: 350 ml



SKU **AOO4502**

0 m+



3 661276 173958

**COMPOSITION:**  
90% Stainless Steel,  
10% 100% Polypropylene  
BPA-free

**MAINTENANCE:**  
Dishwasher-safe

17,5 cm x4 9,5 cm  
10 cm



## Babybols Food containers

TO STORE, REHEAT, AND TRANSPORT  
BABY'S MEALS

- Screw top lid
- Large rewritable surface on the lid
- Stackable containers
- Heat resistant (suitable for microwave, « bain-marie », bottle warmer)
- Fridge and freezer-safe
- Can be sterilised



6 x 180 ml

SKU A004308



3 661276 147355

6 x 250 ml

SKU A004309



3 661276 147362



4 x 120 ml

SKU A004307



3 661276 147348



Multiset:

3 x 120 ml + 3 x 180 ml  
+ 6 x 250 ml + 3 spoons

SKU A004310



3 661276 147379

0 m+

MADE IN  
FRANCE

COMPOSITION:  
100% Polypropylene  
BPA-free  
MAINTENANCE:  
Dishwasher-safe

4 x 120 ml



6 x 180 ml



6 x 250 ml



Multiset



New

## Biosourced Babybols Food containers

TO STORE, REHEAT, AND TRANSPORT  
BABY'S MEALS

- Containers made of more than 94% vegetable material from sugar cane
- Screw top lid
- Large rewritable surface on the lid
- Stackable containers
- Heat resistant (suitable for microwave, « bain-marie », bottle warmer)
- Fridge and freezer-safe
- Can be sterilised

I'm  
green™  
BIO-BASED

I AM MADE OF  
SUGAR CANE



MADE IN  
FRANCE

0 m+

COMPOSITION:  
100% High Density Polyethylene  
BPA free  
MAINTENANCE:  
Dishwasher-safe

6 x 180 ml



6 x 250 ml

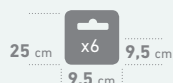

Multiset



6 x 250 ml

SKU A004318



3 661276 179967



6 x 180 ml

SKU A004317



3 661276 179950



Multiset:

8 x 180 ml + 8 x 250 ml

SKU A004316



3 661276 179202





## Isy'Bowls

### Glass food containers

TO STORE, REHEAT, AND TRANSPORT BABY'S MEALS



6 x 250 ml

SKU A004314



3 661276 178861

- Hardwearing, durable and recyclable storage containers made from borosilicate glass
- Withstand very high temperatures and thermal shock
- Can be safely placed in the oven straight from the freezer
- Reheat in the microwave, pan of hot water or bottle warmer
- Can be sterilised
- Hermetic silicone lid
- Maximum flavour retention
- Clear graduation marks
- Stackable containers
- Stain-resistant



Multiset:  
3 x 120 ml + 6 x 250 ml

SKU A004315



3 661276 178878

## Babybols

### Glass food containers

TO STORE, REHEAT, AND TRANSPORT BABY'S MEALS

- Glass storage containers, environmentally-friendly, natural and recyclable material
- Optimal preservation of flavours
- Screw-top lid with airtight silicone seal
- Clear graduation marks
- Large rewritable surface on the lid
- Stackable containers
- Heating in a « bain-marie » is to be preferred
- Fridge and freezer-safe
- Can be sterilised
- Stain-resistant
- A004312 Kit: organic recipes booklet included



4 x 220 ml

SKU A004313



3 661276 165113



Multiset:  
4 x 100 ml + 4 x 220 ml

SKU A004312



3 661276 165106

O m+

#### COMPOSITION:

Bowls: borosilicate glass  
Lids: 100% silicone  
BPA-free

#### MAINTENANCE:

Dishwasher-safe

6 x 250 ml



Multiset



O m+

#### COMPOSITION:

Bowls: glass  
Lids: Polypropylene with silicone seal  
BPA-free

#### MAINTENANCE:

Dishwasher-safe

4 x 220 ml



Multiset





**Fox**  
SKU **A005400**



3 661276 173972



**Dog**  
SKU **A005401**



3 661276 173989

## First'Isy Kit

THE BABY MEALTIME KIT THAT MAKES STARTING WEANING EASY

- Complete mealtime kit: 1 bowl with suction pad + 1 spoon + 1 bib
- Innovative: the spoon is designed for tiny hands and mouths with a 360° ring handle for easy grip
- Smart: textured silicone guards on each side of the spoon stop baby's hand from slipping into the food
- Microwave safe

6-12 m

**COMPOSITION:**  
100% Silicone  
BPA-free

**MAINTENANCE:**  
Dishwasher-safe



## 6-12 months



## Grow'Isy Kit

A KIT TO ENCOURAGE CHILDREN TO LEARN TO LEED THEMSELVES

- Complete mealtime kit: 1 divided plate + 1 drinks bottle + 2 spoons
- Innovative: the inside of the plate has 2 raised cutting edges suitable for left-handers as well as right-handers (rather than needing to use a knife)
- Designed in conjunction with an Occupational Therapist
- Smart: non-serrated safe food cutting fins integrated into the silicone divider plate for breaking and cutting up food independently
- Microwave safe

SKU **A005406**

24-36 m



3 661276 174481

**COMPOSITION:**  
100% Silicone  
BPA-free

**MAINTENANCE:**  
Dishwasher-safe



## 24-36 months



Top-Seller



**Fox**  
SKU **A005402**



**Dog**  
SKU **A005403**



## Learn'Isy Kit

A COMPLETE KIT FOR HELPING BABIES LEARN TO FEED THEMSELVES

- Complete mealtime kit: 1 divided bowl with suction pad + 1 cup + 1 spoon + 1 bib
- Ergonomic: the straw cup and divided bowl have soft handles so baby can grip them easily
- Smart: 3 divided sections so babies can explore different flavours, textures (savoury, sweet etc)
- Microwave safe

15-24 m

**COMPOSITION:**  
100% Silicone  
BPA-free

**MAINTENANCE:**  
Dishwasher-safe



## 15-24 months



**Fox**  
SKU **A005404**



**Dog**  
SKU **A005405**



## Tast'Isy Kit

AN ESSENTIAL KIT TO HELP BABIES ENJOY MEALS ALL BY THEMSELVES

- The mealtime essentials kit: 1 bowl with suction pad + 1 spoon
- Practical: Strong suction pad, ensures sturdy bowl on the table or highchair tray, lightweight and easy to clean in the dishwasher
- Microwave safe

15-24 m

**COMPOSITION:**  
100% Silicone  
BPA-free

**MAINTENANCE:**  
Dishwasher-safe



## Bib'Isy

### Silicone bibs

A KIT OF 2 BIBS THAT ARE EASY TO FASTEN AND WASH

- Curved shape and silicone composition making them easy to clean
- Easy fastening and adjustment
- Durable



SKU A007608

0 m+



3 661276 174016

**COMPOSITION:**  
100% Silicone  
BPA-free

**MAINTENANCE:**  
Dishwasher-safe

32,5 cm



3 cm

22 cm



Fox

SKU A005206



3 661276 174023

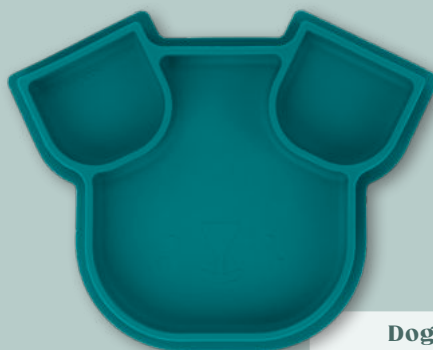

Dog

SKU A005207



3 661276 174030

## Isy'Plate

### Silicone plate

A DIVIDED PLATE FOR EXPLORING NEW FLAVOURS THROUGHOUT THE WEANING PROCESS

- 3 compartments to discover multiple flavours and textures separately
- Larger than a plate, fits easily onto a high chair tray
- Suction base so the plate cannot tip over
- Microwave safe

4 m+

**COMPOSITION:**  
100% Silicone  
BPA-free

**MAINTENANCE:**  
Dishwasher-safe

21,9 cm



2,6 cm

19,5 cm

Top-Seller

## Isy' Cup Silicone cup

AN ERGONOMIC STRAW CUP TO HELP  
BABY LEARN TO DRINK

- Specially designed for small mouths
- Built-in straw with lid to make it easy for baby to drink
- Airtight lid to prevent the liquid spilling out
- Ergonomic: handles and small « feet » for better stability



6 m+

**Fox**  
SKU **A005009**



3 661276 174009

**COMPOSITION:**  
100% Silicone  
BPA-free

**MAINTENANCE:**  
Dishwasher-safe



## Silicone Spoons

THE SOFT SPOON FOR BABY'S FIRST MEALS

- Soft silicone
- Specially designed for small mouths
- Long, sturdy handle for good grip



x5



x 5

SKU **A102407**

3 661276 154513



Blue

SKU **A102405**

3 661276 154490

4 m+

**COMPOSITION:**  
Silicone  
BPA-free

**MAINTENANCE:**  
Dishwasher-safe

x 5



Blue



x5

## Multi-coloured Spoons

THE IDEAL MULTICOLOURED  
TODDLER SPOONS

- Soft material and rounded corners
- Long, sturdy handle for good grip

SKU **A102408**

8 m+



3 661276 154520

**COMPOSITION:**  
100% Polypropylene  
BPA-free

**MAINTENANCE:**  
Dishwasher-safe





# Turbo Pure

## Steriliser / bottle dryer

FOR PERFECT DRYING IN A TOTALLY STERILE ENVIRONMENT



- Sterilises to eliminate 99% of bacteria, odours and calcium build-ups (8-minute cycle)
- Dries & purifies to protect bottles from humidity and eliminate 99% of airborne pollutants such as dust mites, allergens, certain viruses and mould
- Programmable « purifying & drying » function: 30, 45 or 60 minutes
- Keeps baby bottles and accessories in a purified environment for 24 hours
- Universal: detachable nozzles to fit all types of baby bottles, breast pumps, tableware, plastic toys etc.
- Easy to use: « all-in-one » cycle or selection of the functions manually
- Anti-limescale alert
- Automatic shut-off
- LCD control panel
- Includes 2 HEPA filters (to be changed every 6 months)

SKU **A003106**

0 m+



3 661276 152946

**COMPOSITION:**

100% Polypropylene, ABS  
BPA-free

**MAINTENANCE:**

All components, except the electrical part, are dishwasher-safe

**POWER:**

Warmer: 600W  
Drying: 100W

**POWER SUPPLY:**

Operates on mains (plug included)

**PRODUCT SIZE (W x D x H):**

Ø 26 x 41 cm



“Did you know that a baby’s immune system and intestinal flora begin to develop at the age of 6 months? This is why Babymoov and its co-creator parents have developed the **Turbo Pure**, to ensure all your baby’s bottles and accessories are perfectly hygienic.”



**CHARLINE SPEZIALE**

*Babymoov Product Marketing Manager*



## Turbo Steam<sup>(+)</sup> Steriliser

FOR STERILISATION DEEP WITHIN  
BOTTLES, TEATS, AND BREAST PUMPS

- Eliminates up to 99% of the most resistant bacteria
- Sterilises in 6 minutes inside the bottle
- Large capacity: 6 bottles and accessories
- Universal: compatible with all types of bottles, breast pumps, dummies etc



BREVET  
DÉPOSÉ  
PATENT  
PENDING



SKU **A003110**

0 m+



3 661276 160620

**COMPOSITION:**

100% Polypropylene  
BPA-free

**MAINTENANCE:**

All components, except the electrical part, are dishwasher-safe

**POWER:** 550 W

**POWER SUPPLY:**

Operates on mains (plug included)



## Compact Bottle drying rack

COMPLETELY ADJUSTABLE FOR  
GREATER PRACTICALITY

- Several detachable arms for an adjustable configuration
- Can hold up to six bottles and accessories
- Removable water container

SKU **A006006**

0 m+



3 661276 161238

**COMPOSITION:**

100% Polypropylene  
BPA-free

**MAINTENANCE:**

Dishwasher-safe



## Universal Bottle and teat brush

MULTI-PURPOSE BOTTLE BRUSH TO  
PERFECTLY CLEAN ALL CONTAINERS

- 2-in-1: for bottles (wide brush) and teats (small brush)
- Hook on wide brush and suction cup on small brush for hanging and easy drying



SKU **A006007**

0 m+



3 661276 165960

**COMPOSITION:**

Brush: Nylon  
Handle: 100% Polypropylene

**MAINTENANCE:**

Dishwasher-safe



## Dispenser box Babydose

FOR TRANSPORTING PORTIONED POWDERED  
MILK

- Ergonomic design for easy milk pouring
- Air-tight
- Stackable, interchangeable, and sterilisable
- Versatile, can also be used to carry snack



SKU **A004213**

0 m+



3 661276 147409

**COMPOSITION:**

100% Polypropylene  
BPA-free

**MAINTENANCE:**

Dishwasher-safe





**Solutions  
designed for  
a ingenious life**





# Milky Now

## Bottle prep machine

FOR PREPARING BABY BOTTLES QUICKLY, EASILY AND SAFELY



- Practical: heats water for baby bottles or other hot drinks to the exact temperature required, and keeps it at the right temperature for up to 6 hours (between 22°C and 85°C)
- No need to measure: automatically distribute 60 ml\*
- Easy to use: touchscreen to select the required temperature
- For even better control, the actual water temperature is displayed on the screen
- Fast: heats up water to 37°C in only 36 seconds\*\*
- Large capacity (1.1 L): boil water, cool and keep tank at desired temperature for multiple night feeds
- Hygienic: boil water to 100°C to eliminate any potential bacteria and guarantee it is completely clean
- Easy care: stainless steel surface and « CLEAN » function

\* A tolerance is to be taken into account related to the product and the containers used

\*\* Tested with 300 ml of water at room temperature at 20°C

SKU **A002301**

0 m+



3 661276170353

**COMPOSITION:**

Stainless Steel, 100%  
Polypropylene  
BPA-free

**MAINTENANCE:**

Self-cleaning « CLEAN »  
function

**POWER:**

Warmer: 220V / 800W

**POWER SUPPLY:**

Operates on mains (plug  
included)

**PRODUCT SIZE (W x D x H):**

13,5 x 22 x 25,8 cm



“ The **Milky Now** will revolutionise the way parents prepare baby bottles. It instantly heats the water to the exact temperature required, meaning it can also be used as the child grows. ”



**PRESCILLA CONNAN**

BabyMoov Product Manager



New

# Moov & Feed



EXPERT

**BOTTLE  
READY IN LESS  
THAN  
5 MINUTES**

~  
**7H  
AUTONOMY**

PREMIUM

**STAINLESS  
STEEL  
THERMOS**

DURABLE

**REPAIRABLE  
&  
LIFETIME  
WARRANTY**

New

# Moov & Feed

## Travel bottle warmer

A PORTABLE TRAVEL BOTTLE WARMER TO MAKE FEEDING YOUR BABY EASY, WHEREVER YOU ARE

**Mineral Beige**

 SKU **A002103**

3 661276 184398

**Colour 2**

 SKU **A002104**

3 661276 184824

- Precise and fast warming: a bottle ready in less than 5 minutes\*
- Comfortable capacity of 340 ml
- Long-lasting autonomy with automatic « Keep Warm » function to maintain the liquid at the right temperature for 7 hours
- Precise temperature adjustment from 37°C to 50°C
- Versatile: compatible with water, breast milk, and diluted infant formula
- Also works for hot beverages: tea, coffee, and soups
- Ergonomic: easy to hold, can be used with one hand
- Secure cap for easy and leak-free transportation
- Rechargeable lithium battery

0 m+

**COMPOSITION:**

Stainless Steel,  
100% Polypropylene, Lithium  
Battery  
BPA-free

**MAINTENANCE:**

Interior of the stainless steel  
part washable with water and  
soap, using a bottle brush,  
use a soft cloth for the other  
parts

**POWER:**

DC 5V/2A - 65W

**POWER SUPPLY:**

Rechargeable lithium battery  
(USB-C cable included)

**PRODUCT SIZE (W x D x H):**

24,1 x 8 x 8 cm



\* Tested with a 200 ml bottle of room temperature water (20°C) to 37°C

“Did you know that 83% of parents feed their baby bottles outside of their home? And because it's not always easy to warm a bottle while on the go, Babymoov has developed the most efficient travel bottle warmer on the market: the **Moov & Feed**.”

**PRESCILLA CONNAN**

Babymoov Product Manager





## Nutri Smart

### Breast milk / bottle warmer

THE BOTTLE WARMER THAT ADAPTS TO EVERY SITUATION



- Practical: automatically suggests the right heating time once you have entered the amount of milk or baby food to be heated and its temperature (room temperature, refrigerated or frozen)
- Retains the nutrients in breast milk: thanks to the « bain marie » function (65°C max.)
- Fast: takes just 80 seconds\* to heat 65 ml of water to 37°C, using the steam function
- Portable: comes with two plugs, for the home and car
- Programmable: automatic or pre-set operation (15 minutes to 12 hours) to delay the start of the heating process
- Multi-purpose: heats water and food, keeps it warm and gently defrosts
- Universal: suitable for all baby bottles, baby food jars or breast milk pouches (max. 8 cm diameter)

\* Tested with 65 ml of water at a room temperature of 20°C

SKU **AOO2032**

0 m+



3 661276 168855

**COMPOSITION:**

100% Polypropylene, ABS  
BPA-free

**MAINTENANCE:**

All components, except the electrical part, are dishwasher-safe

**POWER:**

12V - 100W  
220 / 240v - 300W

**POWER SUPPLY:**

Operates on Mains (plug included), or on the car lighter socket (plug included)

**PRODUCT SIZE (W x D x H):**

12 x 13 x 16.5 cm



“ The **Nutri Smart** features a pre-programmed steam heating system as well as a « bain marie » to ensure 100% of the nutrients found in breast milk and other foods are retained. ”



**PRESCILLA CONNAN**  
BabyMoov Product Manager





## Tulip Bottle warmer

TO WARM BOTTLES AND BABY FOOD  
JARS

- Fast heating: 2min10 for a 60 ml bottle, 3min30 for 240 ml and 4min for a jar
- Compatible with all feeding bottles on the market (wide neck up to 82 mm) and adaptation ring
- Graduated scale explaining the water/milk ratios (summary table on the back of the bottle warmer)
- Adapter for baby food containers included
- Backlit ring turns red when the bottle warmer is on and green when the bottle is ready
- Automatic shut-off
- Good stability thanks to its wide base



SKU **A002027**

0 m+



3 661276 143074

**COMPOSITION:**

100% Polypropylene  
BPA-free

**POWER:**

230V/300W

**POWER SUPPLY:**

Operates on mains (plug included)

**PRODUCT SIZE (W x D x H):**

17 x 14 x 20,5 cm



## Travel Bottle warmer

THE PORTABLE BOTTLE WARMER  
THAT OPERATES WITHOUT AN ENERGY  
SOURCE

- Infinitely reusable: activate it by twisting the cap, and reactivate it by sterilising
- Adapts to all baby bottles
- Heat is retained thanks to the neoprene cover and its insulated lining
- Carry handle (stroller, changing bag)
- 2-in-1: converts into an all-purpose insulated pouch

SKU **A002102**

0 m+



3 661276 013841

**COMPOSITION:**

Cover: Neoprene  
Heat pad: PVC  
Liquid (non-toxic): Sodium acetate

**POWER SUPPLY:**

Operates without an energy source



## Up & Go Booster seat

THE COMFORTABLE TRAVEL  
BOOSTER SEAT FOR BABY

- Height-adjustable: 7 cm to 14 cm
- Safe: three support straps, three-point harness, four non-slip feet
- Ultra-comfortable backrest and seat
- Easy to transport: carry handle, ultra compact (9 cm thick when folded)



SKU **A009404**

6-36 m  
< 15 kg



3 661276 148178

**COMPOSITION:**

Polyester

**MAINTENANCE:**

Cover machine-washable at 30°C

**PRODUCT SIZE (W x D x H):**

Unfolded: 33,5 x 32 x 34-41 cm  
Folded: 33,5 x 9 x 32 cm





# Comfort range



Baby comfort / mattresses / bouncers / swings

# Babymoov, solutions designed for a peaceful life.

Babymoov works with health experts to develop solutions to improve baby's comfort and sleep.

These unique, often patented, solutions provide optimum support combined with complete safety for parents from the moment their baby is born.



**Dr. Maidenberg**  
French paediatrician,  
co-creator of the  
Lovenest



**Sophia Mighali**  
Swiss midwife,  
co-creator of the  
CloudNest



**FRENCH  
DESIGN**

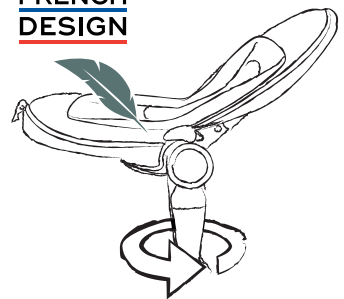

**OEKO-TEX®**  
CONFIDENCE IN TEXTILES



Feels so right

Not to mention more local manufacturing and materials that are kinder to baby's skin... and more respectful of the environment.

## Lovenest Original Anatomical head cushion



THE GENUINELY ANATOMICAL HEAD CUSHION FOR A WELL-ROUND HEAD



**Smokey**

SKU **A050229**



3 661276 171541



**Pinky**

SKU **A050230**



3 661276 171558



**White**

SKU **A050231**



3 661276 171565



0-4 m

**COMPOSITION:**

Top: 100% Organic Cotton  
Bottom: 95% Organic Cotton ,  
5% Elastane  
Filling: 100% Polyurethane foam

**MAINTENANCE:**

Machine-washable at 30°C

**PRODUCT SIZE (W x D x H):**

26 x 23 x 2,8 cm



THE Lovenest  
CONCEPT

- Featuring a specific inclination and shape to ensure even pressure distribution of baby's head to maintain a well-rounded head
- Developed by Dr. Maidenberg, French Paediatrician
- Use from birth until 3 months or when baby can roll over unaided
- Adaptable to bouncers, swings, car seats and strollers
- Soft and breathable organic cotton mesh certified OEKO-TEX®

## Lovenest Natural Care Anatomical anti-bacterial head cushion

THE FIRST NATURALLY ANTIBACTERIAL ANATOMICAL HEAD CUSHION FOR A WELL-ROUND HEAD



THE Lovenest  
CONCEPT

- Featuring a specific inclination and shape to ensure even pressure distribution of baby's head to maintain a well-rounded head
- Developed by Dr. Maidenberg, French Paediatrician
- Use from birth until 3 months or when baby can roll over unaided
- Adaptable to bouncers, swings, car seats and strollers

- Soft and breathable organic cotton mesh certified OEKO-TEX®
- Naturally antibacterial thanks to the copper thread woven into the mesh
- Exclusive technology to eliminate 99.9% of bacteria, reduce odours and protect the skin from infections
- Perforated foam to ensure good ventilation
- Non-slip back for better grip on the sleeping surface



0-4 m

SKU **A050227**



3 661276 167919

**COMPOSITION:**

Top: 100% Organic Cotton  
Bottom: 95% Organic Cotton ,  
5% Elastane  
Filling: 100% Polyurethane foam

**MAINTENANCE:**

Machine-washable at 30°C

**PRODUCT SIZE (W x D x H):**

26 x 23 x 2,8 cm







# Lovenest<sup>(+)</sup> Fresh

## Anatomical head cushion

THE THERMO-REGULATING ANATOMICAL HEAD CUSHION FOR A WELL-ROUND HEAD



**Smokey**

SKU **A050224**



3 661276 154117



**Mosaic**

SKU **A050225**



3 661276 154124

THE Lovenest  
CONCEPT

- Featuring a specific inclination and shape to ensure even pressure distribution of baby's head to maintain a well-rounded head
- Developed by Dr. Maidenberg, French Paediatrician
- Use from birth until 3 months or when baby can roll over unaided
- Adaptable to bouncers, swings, car seats and strollers
- COOL MAX<sup>®</sup> thermo-regulating technology
- Wide and cushioned for optimal support
- Non-slip back for better grip on the sleeping surface

COOLMAX

0-4 m

**COMPOSITION:**

70% Cotton,  
30% Polyester  
Central section: 100% Cool  
Max<sup>®</sup> Polyester  
Filling: 100% Polyurethane foam

**MAINTENANCE:**

Machine-washable at 30°C

**PRODUCT SIZE (W x D x H):**

30 x 24 x 4,5 cm



“ The **Lovenest** is a preventive measure against plagiocephaly. Its unique shape promotes healthy skull development and provides support without restricting movement. It recreates the same comforting and soothing feeling as the womb. ”



**DR. MANUEL MAIDENBERG**

French paediatrician &  
co-creator of the Lovenest



# Babymoov Cosydream

## Anatomical support

THE COMPLETE SOLUTION TO REASSURE BABY AND FACILITATE HIS DIGESTION



**Smokey**

SKU **A050406**



3 661276 143050



**Mosaic**

SKU **A050413**



3 661276 153226



O-3 m

### COMPOSITION:

Mattress: 100% Polyester -  
Binding: 92% Organic Cotton,  
8% Elastane - Filling: 100%  
Polyurethane foam  
Leg support roll: 65% Organic  
Cotton, 35% Polyester -  
Filling: 100% Polyester

### MAINTENANCE:

Machine-washable at 30°C

### PRODUCT SIZE (W x D x H):

40 x 60 x 13 cm



THE Cosydream  
CONCEPT

- Perfect position: back support and raised legs to facilitate baby's digestion
- Integrated head support for a well rounded head
- Ultra-soft, micro-breathable fabric on the head, back and neck
- Reducing effect to reassure baby
- Adjustable leg roll according to age and length
- Polyurethane foam with a density of 25 kg/m<sup>3</sup>
- Soft and breathable organic cotton mesh certified OEKO-TEX®
- Can be used with an inclined plane

# Babymoov Cosydream Fresh

## Anatomical breathable support

THE COMPLETE FRESH AND THERMOREGULATING SOLUTION TO REASSURE BABY AND FACILITATE HIS DIGESTION



New



LYOCELL®



**Off White**

SKU **A050422**

O-3 m



3 661276 182684

### COMPOSITION:

Mattress: 100% Polyester  
Printed fabric: Central section:  
70% Lyocell®, 30% Cotton -  
Binding: 100% Cotton  
Filling: 100% Polyurethane  
foam

Leg support roll: 70% Lyocell®,  
30% Cotto - Filling: 100%  
Polyester

### MAINTENANCE:

Machine-washable at 30°C

### PRODUCT SIZE (W x D x H):

40 x 60 x 13 cm



THE Cosydream  
CONCEPT

- Perfect position: back support and raised legs to facilitate baby's digestion
- Integrated head support for a well rounded head
- Ultra-soft, micro-breathable fabric on the head, back and neck
- Reducing effect to reassure baby
- Adjustable leg roll according to age and length
- Thermoregulating LYOCELL-TENCEL® fabric, naturally super-soft and breathable
- Polyurethane perforated foam with a density of 25 kg/m<sup>3</sup>
- Can be used with an inclined plane

“ Developed with experts (Paediatricians, Osteopaths and Midwives) and co-creating parents, the **Cosydream** reassures baby in a non-restrictive adjusted anatomical position which helps to improve the symptoms of colic and reflux. ”



**ALEXANDRA MERMOUD**  
Babymoov Product Manager



## Babymoov Cosydream<sup>(+)</sup> Sloping anatomical support

THE FIRST ERGONOMIC BABY SUPPORT SLOPING MATTRESS

THE  
Cosydream  
CONCEPT



- Perfect position: back support and raised legs to facilitate baby's digestion
- Integrated head support for a well rounded head
- Ultra-soft, micro-breathable fabric on the head, back and neck
- Reducing effect to reassure baby
- Adjustable leg roll according to age and length
- 10° incline to help baby breathe and digest easily
- Safety belt to keep baby comfortably settled on their back and prevent them from slipping
- Removable cover and reusable transport bag made of recycled plastic

SKU **A050417**

0-3 m



3 661276 161702

#### COMPOSITION:

Grey mottled, fabric under the head and binding: 100% organic Cotton  
White 3D mesh, exterior and waistband: 100% Polyester  
Roller padding: 100% Polyester  
Mattress padding: 100% Polyurethane microbeads

#### MAINTENANCE:

Cover and roll machine-washable at 30°C

#### PRODUCT SIZE (W x D x H):

60 x 41 x 17 cm



## Cosymat Antibacterial Sloping mattress

PROTECTING THE DELICATE SKIN OF THE BABY, RELIEVING REGURGITATION, AND HELPING BREATHING

New

30%  
recycled  
polyester &  
organic  
cotton



70%  
foam

- 10° incline to promote baby's breathing and digestion
- Firm and premium: high-density foam of 23 kg/m<sup>3</sup>
- Antibacterial, without any chemical treatment
- Soft cover made of organic cotton and recycled NEW LIFE HEALTHCARE™ Polyester thread
- To be placed under the mattress or under the fitted sheet



SKU **A050014**

0 m+



3 661276 184169

#### COMPOSITION:

Top: 92% Polyester, 8% Organic Cotton  
Bottom: 100% Polyester  
Foam: 100% Polyurethane

#### MAINTENANCE:

Cover machine-washable at 30°C

#### PRODUCT SIZE (W x D x H):

60 x 35 x 7 cm



# CloudNest

## Anti-colic reducer



BREVET  
DÉPOSÉ  
PATENT  
PENDING



THE 3-IN-1 COCOON TO REASSURE, AID DIGESTION AND RELIEVE COLIC

- Patented and co-created with Swiss midwife Sophia Mighali
- Reducer effect to reassure baby (Moro startle reflex) and imitate the feeling of being in a parent's arms
- Adjustable lower section (4 press-studs) to lift the legs and recreate the foetal position to aid digestion
- Built-in anti-colic heating pad (flax seeds subjected to a natural anti-germination treatment) to relieve colic
- OEKO-TEX® certified organic cotton jersey and breathable mesh at the head
- 2 cm thick Polyurethane foam with a density of 36 kg/m<sup>3</sup> mattress
- Compact and easy to carry in its carry bag

OEKO-TEX®  
CONFIDENCE IN TEXTILES

SKU **A039003**

0-3 m  
< 9 kg



3 661276 169128

#### COMPOSITION:

Grey marl: 50 % Organic Cotton,  
50 % Polyester  
3D mesh: 100 % Polyester  
Mattress: 100% Polyurethane -  
Cover: 100% Polypropylene  
Heating pad: 100% Organic  
Cotton, Linseed  
Roll: Polypropylene - Filling:  
Polyeste

#### MAINTENANCE:

Cover machine-washable at  
30°C

#### PRODUCT SIZE (W x D x H):

82,5 x 46 x 2 cm



flax seeds

“As a midwife, I discovered that surrounding babies with padding, lifting their legs and applying warmth and weight to their tummies has an extremely positive impact on their sleep and health. And the **CloudNest** creates all these conditions.”



**SOPHIA MIGHALI**

Swiss midwife & co-creator  
of the CloudNest



## Newborn reducer Universal Cosymorpho

TO REASSURE AND SUPPORT BABY IN ALL ENVIRONMENTS  
AT HOME AND ON-THE-GO

- Universal to improve the comfort of all types of bouncers, swings, car seats, or carrycots (2, 3 or 5 point harness with removable straps)
- Reducing effect with padded edges to reassure baby
- Integrated morphological head support for a well rounded head
- Ultra soft micro-breathable fabric on head, back and neck
- Viscoelastic memory foam for optimal comfort
- Available in Smokey with velour edges or Fresh Smokey with breathable material

0-6 m

**COMPOSITION:**  
Mattress: 100% Polyester  
Sides: 100% Polyester  
Filling: 100% Polyurethane foam

**MAINTENANCE:**  
Hand-washable

**PRODUCT SIZE (W x D x H):**  
34 x 60 x 7 cm

34 cm  7 cm  
37,5 cm

**Smokey**

SKU **A050408**



3 661276 143241



**Fresh Smokey**

SKU **A050409**



3 661276 143258





**Solutions**  
**designed for**  
**a peaceful life**



	<b>Loveneest Original</b>	<b>Loveneest Natural Care</b>	<b>Loveneest(*) Fresh</b>	<b>Babymoov Cosydream</b>	<b>Babymoov Cosydream Fresh</b>	<b>Babymoov Cosydream(*)</b>	<b>Cosymat Antibacterial</b>	<b>CloudNest</b>	<b>Cosymorpho</b>
	 A050229 A050230 A050231	 A050227	 A050224 A050225	 A050406 A050413	 A050422	 A050417	 A050014	 A039003	 A050408 A050409
<b>Age</b>	0-4 m			0-3 m			0 m +	0-3 m ≤ 9 kg	0-6 m
<b>Fits with...</b>	Bouncers, baby swings, carrycots, car seats, strollers			Playpen, activity nest			Beds, Playpen, activity nest	Playpen, activity nest	Universal
<b>Patented</b>				●	●			●	
<b>Transport bag</b>				●	●	●	●	●	
<b>Local production</b>	●	●	20 24	●	●	●	●	●	20 24
<b>FEATURES</b>									
<b>Head support</b>	●	●	●	●	●	●			●
<b>Keeps baby on the back</b>	●	●	●	●	●	●	●	●	●
<b>Support roll</b>				●	●	●		●	
<b>Enveloping form</b>				●	●	●		●	
<b>Inclination</b>						●	●		
<b>Lifted legs</b>				●	●	●		●	
<b>Heating pad</b>								●	
<b>COMPOSITION</b>									
<b>Organic Cotton</b>	●	●		●		●	●	●	
<b>Oeko-Tex®</b>	●	●		●	●	●	●	●	
<b>Antibacterial</b>		●					●		
<b>Foam with holes</b>		●			●				
<b>Thermo-regulating</b>			●		●				
<b>Non slip</b>		●	●						
<b>MAINTENANCE</b>									
<b>Removable cover</b>						●	●	●	
<b>Machine-washable</b>	●	●	●	●	●	●	●	●	handwash



# Babymoov, solutions designed for a gentle life.

A baby spends **18 hours** a day sleeping, that's why, at Babymoov, we consider the mattress as a true living space!

We have put our expertise in sleep comfort at the service of a unique range of mattresses, which bring together all the essential ingredients for quality sleep.

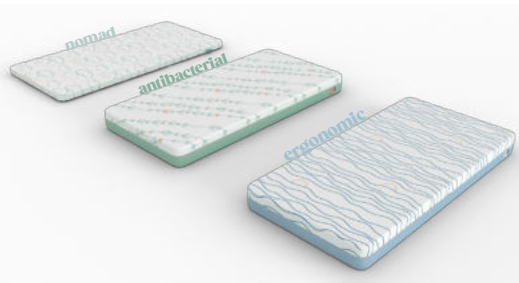

Our products combine baby's comfort, eco-responsibility, and safety: above-average density that reduces the risk of suffocation, Oeko-Tex® and Certipur® certified materials, ergonomic and antibacterial designs, 10-year warranty... peace of mind and durability are the keywords of the Cosy Lite mattress range!



OEKO-TEX®  
CONFIDENCE IN TEXTILES



**With a 10-year warranty, peace of mind and durability** are the keywords of this range.

**Must have benefits for better and longer sleep for babies.**



# Cosy'Lite Nomad

## Travel mattress

A SUPER SOFT TRAVEL MATTRESS TO TAKE ANYWHERE WITH YOU



30%  
recycled  
polyester



70%  
foam



OEKO-TEX®  
CONFIDENCE IN TEXTILES

60 x 120

SKU **A050700**

O m+



3 661276 175266

**COMPOSITION:**

Cover: 100% Polyester  
Foam: 100% Polyurethane

**MAINTENANCE:**

Cover machine-washable at 30°C

**PRODUCT SIZE (W x D x H):**

120 x 60 x 4,5 cm  
Rolled: ø26 x 60 cm



**THICKNESS**  
4.5 cm

**DENSITY**  
23 kg/m<sup>3</sup>



### THE Cosy'Lite CONCEPT

- OEKO-TEX® and et CERTIPUR® certified mattress
- Soft and comfortable: super soft cover for baby's sensitive skin, and high quality foam for restful sleep
- Cover made of NEW LIFE™ threads from recycled plastic bottles
- Polyurethane foam with a density of 23 kg/m<sup>3</sup>
- 4.5 cm thick mattress
- One size only to fit all cots and travel cots measuring 60 x 120 cm
- Compact and portable: mattress can be easily rolled up and carried in its recyclable and OEKO-TEX® certified carry bag

“**Cosy'Lite Nomad** is the ideal travel mattress to ensure soft naps and nights for the baby. Compact and very comfortable, it rolls up and can be easily taken anywhere thanks to its carrying bag.”



**ALEXANDRA MERMOUD**  
BabyMooV Product Manager



New

# Cosy'Lite Antibacterial

EXPERT

FIRM AND  
HIGH-QUALITY  
DENSITY  
OF 32 KG/M<sup>3</sup>

PREMIUM

EXCLUSIVE  
TECHNOLOGY:  
ANTIBACTERIAL

DURABLE

COVER MADE  
OF RECYCLED  
THREAD AND  
ORGANIC  
COTTON

FOAM MADE  
FROM SOY

New

COMFORT

# Cosy'Lite Antibacterial Mattress

THE MATTRESS THAT ELIMINATES BACTERIA TO PROTECT  
THE DELICATE SKIN OF THE BABY



30%  
recycled  
polyester  
&  
organic  
cotton

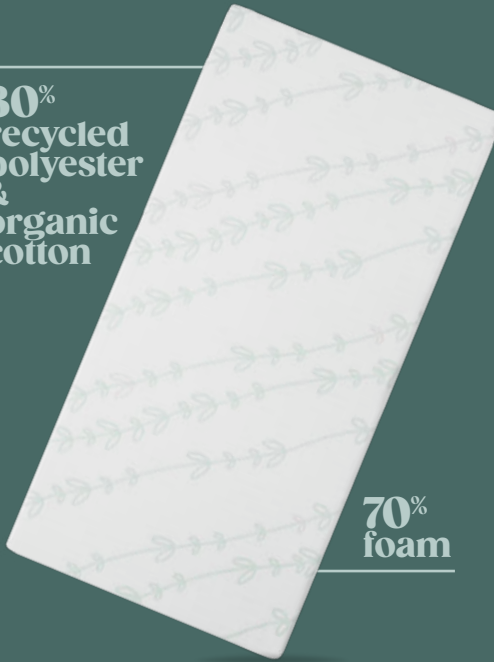

70%  
foam

60 x 120 cm

SKU **A050702**



3 661276 179615

70 x 140 cm

SKU **A050704**



3 661276 179639

O m+

**COMPOSITION:**

Top: 92% Polyester, 8% Organic Cotton  
Bottom: 100% Polyester  
Foam: 100% Polyurethane

**MAINTENANCE:**

Cover Machine-washable at 30°C

**60 x 120 cm**



**70 x 140 cm**



**THICKNESS**  
10 cm

**DENSITY**  
32 kg/m<sup>3</sup>

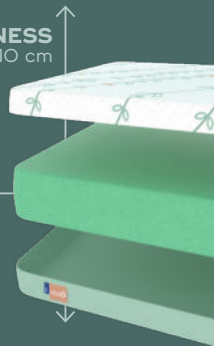

THE Cosy'Lite  
CONCEPT

- OEKO-TEX® and et CERTIPUR® certified mattress
- Soft and comfortable: super soft cover for baby's sensitive skin, and high quality foam for restful sleep
- Firm and premium: BIOCELL® foam made from soy with a high density of 32 kg/m<sup>3</sup>
- 10 cm thick mattress
- Antibacterial, without chemical treatment, thanks to the copper and silver thread knitted into the stitch
- Exclusive NEW LIFE HEALTHCARE™ technology: eliminates bacteria, reduces odors, and protects the skin from infections
- Organic cotton cover and NEW LIFE™ threads made from recycled plastic bottles
- Provides optimal support and comfort to prevent the risk of suffocation
- Available in 2 sizes: suitable for all beds of 60 x 120 cm and 70 x 140 cm
- Mattress sold compressed and rolled

“**Cosy'Lite Antibacterial** is equipped with an exclusive technology that is antibacterial without any chemical treatment. Combined with high density, it offers optimal support and comfort for restful sleep.”



**ALEXANDRA MERMOUD**  
Babymoov Product Manager



New

# Cosy'Lite Ergonomic

EXPERT

FIRM AND  
HIGH-QUALITY  
DENSITY  
OF  
28 KG/M<sup>3</sup>

PREMIUM

BREATHABLE  
COVER AND  
FOAM  
TO PREVENT  
FLAT HEAD

DURABLE

COVER  
MADE OF  
RECYCLED  
NEW LIFE™  
THREAD

New

COMFORT

# Cosy'Lite Ergonomic Mattress

THE BREATHABLE ANTI-FLAT HEAD MATTRESS  
FOR SERENE GROWTH



30%  
recycled  
polyester



70%  
foam

60 x 120 cm

SKU **A050701**



3 661276 179608

70 x 140 cm

SKU **A050703**



3 661276 179622

0 m+

**COMPOSITION:**

Cover: 100% Polyester  
Foam: 100% Polyurethane

**MAINTENANCE:**

Cover Machine-washable  
at 30°C

60 x 120 cm



70 x 140 cm

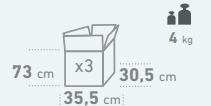

THICKNESS  
10 cm

DENSITY  
28 kg/m<sup>3</sup>

30 kg/m<sup>3</sup>

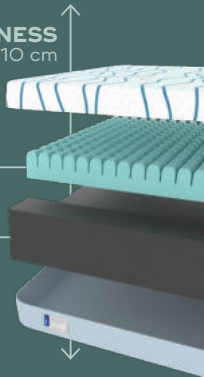

THE Cosy'Lite  
CONCEPT

- OEKO-TEX® and et CERTIPUR® certified mattress
- Soft and comfortable: super soft cover for baby's sensitive skin, and high quality foam for restful sleep
- Firm and premium: 2 high-density foams of 28 kg/m<sup>3</sup> and 30 kg/m<sup>3</sup>
- 10 cm thick mattress
- Cool and breathable thanks to the cellular foam
- Exclusive DRIRELEASE® technology: breathable and hydrophobic to wick away moisture and regulate temperature
- « Eggshell » bubble foam to support the spine and reduce pressure on the head to prevent plagiocephaly (flat head)
- Cover made of NEW LIFE™ threads manufactured from recycled plastic bottles and water-based glue (non-chemical, solvent-free) between the two foam layers
- Provides optimal support and comfort to prevent the risk of suffocation
- Available in 2 sizes: suitable for all beds of 60 x 120 cm and 70 x 140 cm
- Mattress sold compressed and rolled

“Cosy'Lite Ergonomic is cool, breathable, and thermo-regulating. Made of 2 layers of high-density foam, it adapts to the baby's body shape and provides support and comfort for optimal growth.”



**ALEXANDRA MERMOUD**  
Babymoov Product Manager



**Solutions  
designed for  
a cosy life**



# #CosyLite



	Nomad	Antibacterial	Ergonomic
	A050700 ●	A050702 ● A050704 ●	A050701 ● A050703 ●
Made in Europe	●	●	●
Foam density	23 kg/m <sup>3</sup>	32 kg/m <sup>3</sup>	28 kg/m <sup>3</sup> + 30 kg/m <sup>3</sup>
Thickness	4,5 cm	10 cm	10 cm
Size	60 x 120 cm	60 x 120 cm 70 x 140 cm	60 x 120 cm 70 x 140 cm
Transport bag	●		
FEATURES			
Thermoregulating			●
Ergonomic			●
Antibacterial		●	
COMPOSITION			
Organic Cotton		●	
Oeko-Tex®	●	●	●
Certipur®	●	●	●
« Eggshell » bubble foam			●
Biocell® Foam		●	
New Life™ threads	●	●	●
MAINTENANCE			
Removable cover	●	●	●
Machine-washable	●	●	●





# Graphik

## Baby bouncer

THE EASY-TO-CARRY BOUNCER FOR OPTIMUM COMFORT RIGHT FROM BIRTH

- Bouncing or fixed position
- Reclining backrest
- Removable head support
- Cosy cushioned seat
- Detachable and adjustable activity arch (5 different positions)
- Easy to transport and store: carry handles and folds down to a compact size

0 m+  
< 9 kg

**COMPOSITION:**  
100% Polyester  
Lining: 100% EVA foam

**MAINTENANCE:**  
Cover Hand-washable

**PRODUCT SIZE (W x D x H):**  
Unfolded: 79 x 45 x 31 cm  
Folded: 79 x 42 x 11,5 cm



**Peach**

SKU **AO12432**



3 661276 149465



**Blue**

SKU **AO12433**



3 661276 149472







# Swoon Air

## Baby bouncer

THE 360° HEIGHT-ADJUSTABLE BOUNCER WITH 1-CLICK CONTROL



SKU **A012436**

0 m+  
< 9 kg



3 661276166110

**COMPOSITION:**

Newborn reducer: 50% Cotton, 50% Polyester  
Binding: 100% Polyester  
Filling: 100% Polyester foam  
Cover: 100 % Polyester

**MAINTENANCE:**

Reducer and cover: machine-washable at 30°C

**PRODUCT SIZE (W x D x H):**

Footprint: 97 x 97 cm  
Height: 95 cm



THE **Swoon**  
CONCEPT

- Comfortable and secure: extra soft newborn cushion insert with 5-point safety harness
- Recline: 5 positions easily adjustable with one hand, 2 for the seat and 3 for the back
- Awakening: play arch with 3 sensory toys, adjustable on 3 positions and removable
- Innovative rotation system: 360° seat rotation, with locking system
- Innovative height adjustment system: can be easily adjusted by pressing the central button once
- Suitable for all situations: 5 positions (94 cm - 92 cm - 90 cm - 88 cm - 86 cm)

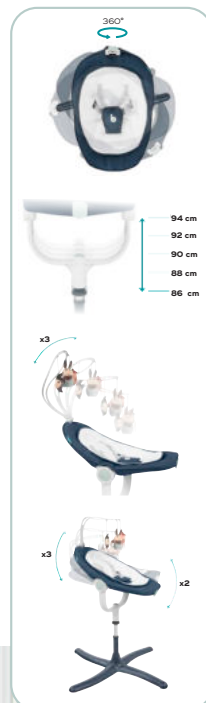

# Swoon Light

## Baby swing

THE MOTORISED COMFORT SWING WITH  
NATURAL ROCKING MOTION



SKU **A055017**

0 m+  
< 9 kg



3 661276170810

**COMPOSITION:**

100% Polyester  
Lining: 100% EVA foam

**MAINTENANCE:**

Cover machine-washable at  
30°C

**POWER SUPPLY:**

Operates with 4 x LR14  
batteries (not included) or on  
mains (adapter included)

**PRODUCT SIZE (L x p):**

Footprint: 75 x 77 cm  
Height: 75 cm



THE **Swoon**  
CONCEPT

- Comfortable and secure: confort seat with 5-point safety harness
- Recline: 2 reclining positions to adjust baby's position (asleep or awake)
- Awakening: play arch with 2 toys, adjustable on 3 positions
- Natural rocking, 5 speeds: reproduces the same soothing motion baby would experience when being rocked in arms
- Programmable rocking time: 10, 20 or 30 minutes
- Comfortable headrest adjustable so it is always at the right height for baby's head
- 8 built-in lullabies, with adjustable volume
- Motion detector: rocking is automatically triggered if baby moves



# Swoon Touch

## Baby swing

THE REMOTE CONTROL MOTORISED COMFORT SWING WITH NATURAL ROCKING MOTION



SKU **A055016**

0 m+  
< 9 kg



3 661276169142

**COMPOSITION:**

100% Polyester  
Lining: 100% EVA foam

**MAINTENANCE:**

Cover machine-washable at 30°C

**POWER SUPPLY:**

Operates with 4 x LR14 batteries (not included) or on mains (adapter included)

**PRODUCT SIZE (L x p):**

Footprint: 75 x 77 cm  
Height: 75 cm



THE **Swoon**  
CONCEPT

- Comfortable and secure: extra soft newborn cushion insert with 5-point safety harness
- Recline: 2 positions to adjust baby's position (asleep or awake)
- Awakening: play arch with 2 toys, adjustable on 3 positions
- Natural rocking, 5 speeds: reproduces the same soothing motion baby would experience when being rocked in arms
- Programmable rocking time: 10, 20 or 30 minutes
- Remote control included for controlling the rocking, speed, movement detector, timer and sound
- 8 built-in lullabies, with adjustable volume
- Motion detector: rocking is automatically triggered if baby moves

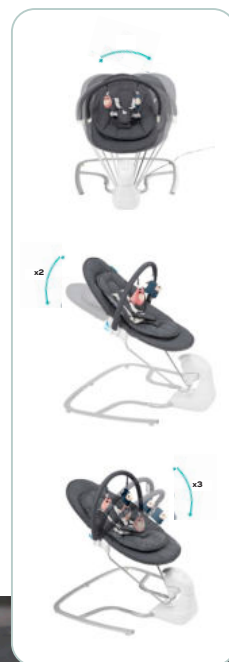

New

# Swoon Hoop



EXPERT

4  
ROCKING  
MOTIONS AND  
ADJUSTABLE  
SEAT

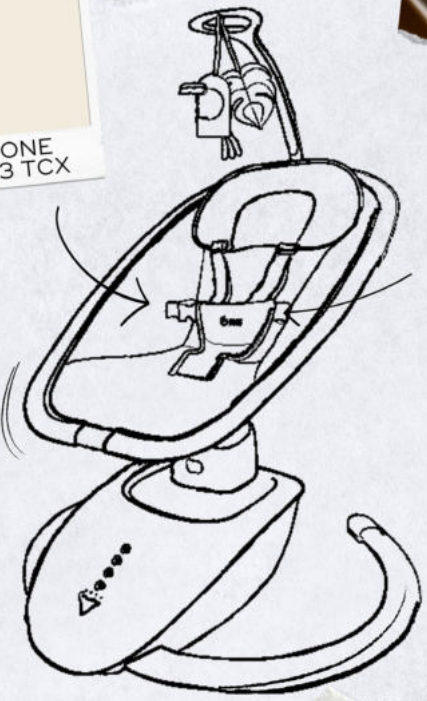

PREMIUM

SLEEK DESIGN,  
NATURAL TONES  
AND TRENDY  
COLORS



DURABLE

LIFETIME  
WARRANTY

New

COMFORT



# Swoon Hoop

## Baby swing

THE TRENDY SWING TO FIT EVERY HOMES



### THE SWOON CONCEPT

- Comfortable and secure: confort seat with 5-point safety harness
- Recline: 2 reclining positions to adjust baby's position (asleep or awake)
- Awakening: play arch with 2 toys
- Rotation system: 90° swivel seat
- 4 rocking speeds to soothe the baby according to their needs
- 4 gentle rocking motions, as smooth as a parent's arms
- Programmable rocking time: 10 to 30 minutes
- 8 built-in lullabies (melodies, white noise, and nature sounds), with adjustable volume

### Sand Dune

SKU **A055022**

0 m+  
< 9 kg



3 661276 185319

#### COMPOSITION:

100% Polyester

#### MAINTENANCE:

Cover machine-washable at 30°C

#### POWER SUPPLY:

Operates on mains (adapter included)

#### PRODUCT SIZE (L x p):

Footprint: 74 x 70,5 cm

Height: 85 cm



“ The **Swoon Hoop** Swing, with its modern and trendy design, offers absolute comfort to the baby with its soft and plush seat. Its 4 swinging movements are as smooth as a parent's arms. ”



**LOUISE MARQUES**

*Babymoov Product Manager*



**Solutions**  
**designed for**  
**a beautiful life**

Top-Seller

COMFORT



# Swoon Motion

## Baby swing

THE 360° SWING ULTRA COMFORTABLE FROM BIRTH



Zinc  
SKU **A055008**



3 661276 014763



Terracotta  
SKU **A055018**



3 661276 173996



Blue Petal  
SKU **A055019**



3 661276 175457

THE SWOON  
CONCEPT

- Comfortable and secure: extra soft newborn cushion insert with 5-point safety harness
- Recline: 5 positions easily adjustable with one hand, 2 for the seat and 3 for the back
- Awakening: play arch with 3 sensory toys, adjustable on 3 positions and removable
- Innovative 360° seat rotation system, with locking system
- 5 rocking speeds and 2 rocking modes: side to side or back and forth
- Programmable rocking time: 10, 20 or 30 minutes
- Motion detector: rocking is automatically triggered if baby moves
- 10 built-in lullabies (melodies and nature sounds), with adjustable volume

0 m+  
< 9 kg

**COMPOSITION:**

Newborn reducer:  
50% Cotton, 50% Polyester  
Binding: 100% Polyester  
Filling: 100% Polyester foam  
Cover: 100 % Polyester

**MAINTENANCE:**

Reducer and cover: machine-washable at 30°C

**POWER SUPPLY:**

Operates with 4 x D/LR20 batteries (not included) or mains (adapter included)

**PRODUCT SIZE (L x P):**

Footprint: 82 x 63 cm  
Height: 110 cm

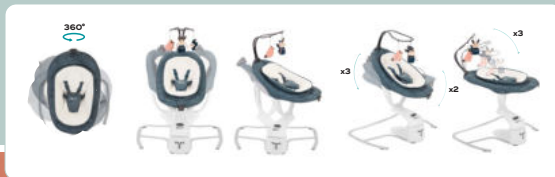

“ A real little cosy nest thanks to its soft materials, the **Swoon Motion** has been designed to simplify the life of parents, keeping an eye on their baby at all times. ”



**DOMITILLE BARDET**  
BabyMoov Product Manager



# Solutions designed for a loving life





Top-Seller

COMFORT



# Swoon Evolution

## Baby swing

A SWING WITH SEVERAL TYPES OF MOVEMENTS THAT FEEL AS SMOOTH AS A PARENT'S ARMS



Curl White  
SKU **A055020**

0 m+  
< 9 kg



3 661276175518

**COMPOSITION:**

Newborn insert: Top: 75% Polyester, 25% Cotton - Filling: 100% Polyester - Back: 98% Polyester, 2% Elastane  
Cover: 100% Polyester  
Toys: 100% Polyester

**MAINTENANCE:**

Cushion is machine washable at 30°C  
Cover is machine washable on the ultra delicate/hand wash programme. Do not spin. We recommend using a protective laundry net

**POWER SUPPLY:**

Operates on mains (adapter included)

**PRODUCT SIZE (L x p):**

Footprint: 69 x 63 cm

Height: 93 cm



THE SWOON CONCEPT

- Comfortable and secure: extra soft newborn cushion insert with 5-point safety harness
- Recline: 5 positions easily adjustable with one hand, 2 for the seat and 3 for the back
- Awakening: play arch with 3 sensory toys, adjustable on 3 positions and removable
- Innovative 360° seat rotation system
- 5 rocking speeds and 8 different, extremely smooth movements
- Programmable rocking time: 10, 20 or 30 minutes
- Remotely controlled: remote control included for adjusting the rocking, speed, timer and sound from a distance
- 12 built-in lullabies (melodies, white noise and nature sounds), with adjustable volume
- Designed in collaboration with a French influencer

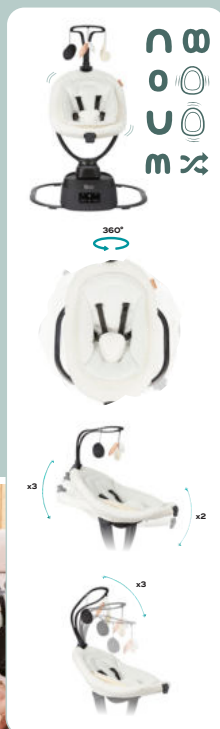

“ The **Swoon Evolution** is a real technological jewel with a modern design and ultra soft and trendy materials. It offers a combination of 8 ultra-fluid rocking movements with 5 speeds, comparable to the sensations felt in the parents' arms. ”



@BABYATOUTPRIX  
French influencer & co-creator of the Swoon Evolution



New

# Swoon Evolution Connect

EXPERT

UNIQUE  
APPLICATION  
FOR SHARING  
PERSONALIZED  
SOUNDS

PREMIUM

8 MOVEMENTS  
~  
360° ROTATION

DURABLE

LIFETIME  
WARRANTY

New

COMFORT



# Swoon Evolution Connect

## Baby swing

THE FIRST SWING THAT PROVIDES SOUND COMFORT THROUGH COMPLETE CUSTOMIZATION

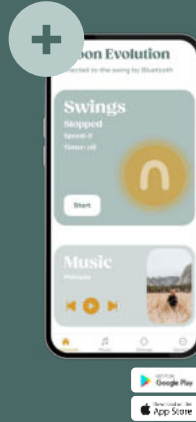

**Mocca**  
SKU **AO55021**

0 m+  
< 9 kg



3 661276 182417

**COMPOSITION:**

Newborn insert: 100% Polyester - Filling: 100% Polyester  
Cover: Behind: 85% Polyester, 15% Cotton - Back and Filling: 100% Polyester  
Toys: 100% Polyester

**MAINTENANCE:**

Cushion is machine washable at 30°C  
Cover is machine washable on the ultra delicate/hand wash programme. Do not spin. We recommend using a protective laundry net

**POWER SUPPLY:**

Operates on mains (adapter included)

**PRODUCT SIZE (L x p):**

Footprint: 69 x 63 cm  
Height: 93 cm



THE SWOON CONCEPT

- Comfortable and secure: extra soft newborn cushion insert with 5-point safety harness
- Recline: 5 positions easily adjustable with one hand, 2 for the seat and 3 for the back
- Awakening: play arch with 3 sensory toys, adjustable on 3 positions and removable
- Innovative 360° seat rotation system
- 5 rocking speeds and 8 different, extremely smooth movements
- Programmable rocking time: 10, 20 or 30 minutes
- Connected and remotely controllable from the dedicated mobile application
- 12 built-in lullabies (melodies, white noise, and nature sounds), adjustable volume
- Custom sound creation by parents and loved ones
- Streaming music platform content playback
- Exclusive thematic Babymoov playlists available on the application

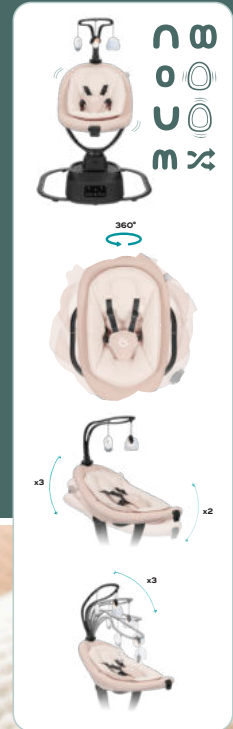

“ The **Swoon Evolution Connect** is the stylish and technological swing for increasingly connected parents. It offers a unique user experience with its application to play hundreds of musical contents or record your own sounds. ”



**DOMITILLE BARDET**  
Babymoov Product Manager



# swoon evolution connect

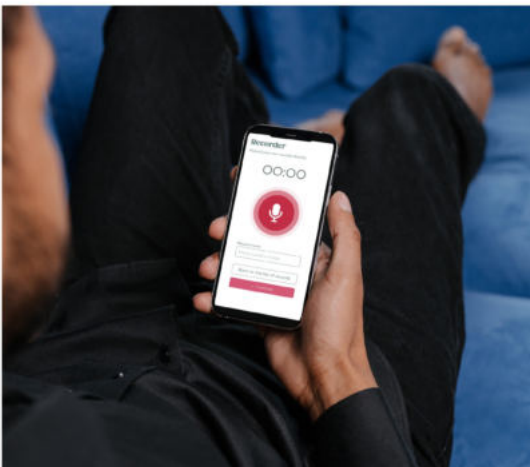
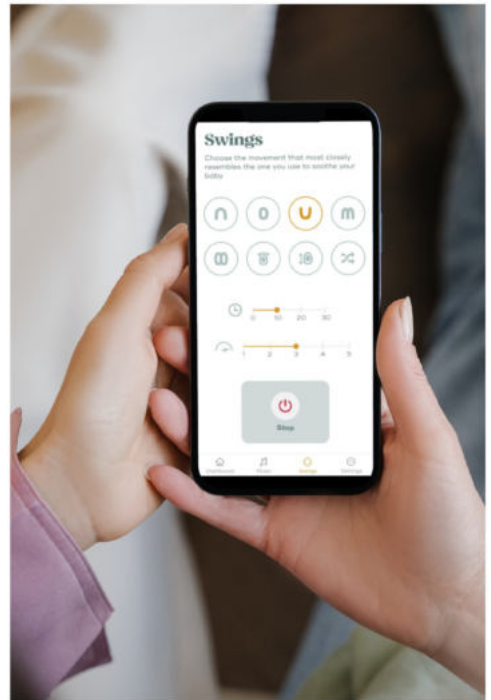
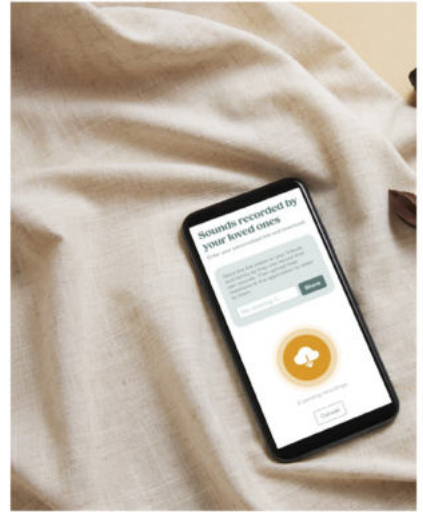

# #Swoon



	<b>Swoon Light</b>	<b>Swoon Touch</b>	<b>Swoon Hoop</b>	<b>Swoon Motion</b>	<b>Swoon Evolution</b>	<b>Swoon Evolution Connect</b>
	A055017 ●	A055016 ●	A055022 ●	A055008 ● A055018 ● A055019 ●	A055020 ●	A055021 ●
Age	0 m+ < 9 kg	0 m+ < 9 kg	0 m+ < 9 kg	0 m+ < 9 kg	0 m+ < 9 kg	0 m+ < 9 kg
Newborn cushion		●		●	●	●
Headrest	●		●			
5-point harness	●	●	●	●	●	●
Recline	<i>Backrest: x2</i>	<i>Backrest: x2</i>		<i>Backrest: x3 Seat: x2</i>	<i>Backrest: x3 Seat: x2</i>	<i>Backrest: x3 Seat: x2</i>
Seat rotation			90°	360°	360°	360°
FUNCTIONS						
Rocking speed	x5	x5	x4	x5	x5	x5
Movements	x1	x1	x4	x2	x8	x8
Motion detector	●	●		●		
Lullabies	x8	x8	x8	x10	x12 + white noise	x12 + white noise / sound customisation
Play arch	● 2 toys	● 2 toys	● 2 toys	● 3 toys	● 3 toys	● 3 toys
Remote control		●			●	
Connected (application)						●
MAINTENANCE						
Removable cover	●	●	●	●	●	●
Machine-washable	●	●	●	●	●	●





# Well Being range



Humidifiers / nightlights

# Babymoov, solutions designed for a peaceful life.

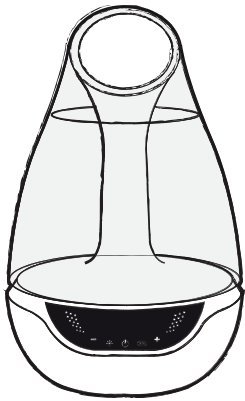

Did you know? The right level of humidity in the home has an impact on air quality and therefore on your baby's health.

According to the experts, that level is **between 40% and 50%**. This helps limit any respiratory problems in babies.

Parents can rely on our humidifiers to reduce infections or irritations related to lack of humidity.



And let's not forget our nightlights, which accompany baby to the land of nod, with their soft light and relaxing sounds.

SKU **AO47012**

O m+



3 661276 148543

**COMPOSITION:**

Polypropylene, ABS

**MAINTENANCE:**

Access to the water tank for easy cleaning

**POWER:**

220 / 240V - 50 / 60Hz

**POWER SUPPLY:**

Operates on mains (plug included)

**PRODUCT SIZE (W x D x H):**

29 x 21,5 x 18 cm



## Hygro Humidifier

### THE SIMPLE, QUIET HUMIDIFIER

- Quiet (45 dB)
- Cool mist with adjustable flow rate
- Optimum operating time for continuous diffusion from bedtime until wake-up time (operates for up to 18 hours)
- Automatic shut-off at low water level
- Easy to use: ON/OFF button

Top-Seller

## Hygro<sup>(+)</sup> Humidifier

TO GUARANTEE HEALTHY AIR IN YOUR BABY'S SURROUNDINGS



- Quiet ultrasonic technology (25dB)
- Manual or automatic humidity setting (from 30 to 90%) at the desired time
- 360° swivel cool mist outlet (cool mist)
- Adjustable mist output (5 levels)
- Optimum operating time for continuous diffusion from bedtime until wake-up time (operates for up to 22 hours)
- Multi-coloured night light (7 colours)
- Backlit touchscreen displaying the humidity, temperature, and timer
- Essential oil diffuser
- Automatic shut-off at low water level

SKU **AO47011**

O m+



3 661276 144187

**COMPOSITION:**

Polypropylene, ABS

**MAINTENANCE:**

Access to the water tank for easy cleaning

**POWER:**

220 / 240V - 50 / 60Hz

**POWER SUPPLY:**

Operates on mains (plug included)

**PRODUCT SIZE (W x D x H):**

26 x 24 x 34 cm



“Hygro<sup>(+)</sup>, the smart, silent humidifier has a designer look and checks the atmosphere in the nursery to ensure the air is healthy whilst baby sleeps.”



**PRESCILLA CONNAN**  
Babymoov Product  
Manager







## Wall Nightlight

ESSENTIAL FUNCTIONS FOR A HANDY WALL NIGHT LIGHT

- Two brightness settings
- Low-consumption LED
- No burn risk: does not become hot
- ON/OFF button to control energy consumption
- Emits a natural white light
- Adapts to all sockets: plug rotates through 90°

SKU **AO15014**

O m+



3 661276 012462

**COMPOSITION:**

ABS

**POWER:**

0,3 W



## Squeezy Nightlight

THE SQUEEZY, SENSORY NIGHTLIGHT COMPANION SAFE FOR IN THEIR BED OR COT

- « Air Sensor » technology to switch on, adjust the brightness and to switch off the nightlight
- Made of very soft silicone
- Battery life of over 200 hours
- Built-in timer (30 minutes)
- Compact



SKU **AO15026**

O m+



3 661276 152687

**COMPOSITION:**

Silicone, ABS

BPA-free

**POWER SUPPLY:**

Operates with a rechargeable lithium battery (micro-USB cable included)

**PRODUCT SIZE (W x D x H):**

ø10 x 10,5 cm





# Safety range



Audio babymonitors / video babymonitors /  
motorised video babymonitors

# Babymoov, solutions designed for a clever life.

Innovation, durability, ease of use...

A complete range of high-performance audio and video baby monitors to suit the lifestyles of all young parents.

Today, our baby monitors are the only ones on the market to carry the **LONGTIME**® label, a guarantee of longevity, robustness and repairability. They're also lifetime warranty, for durability and to give parents peace of mind

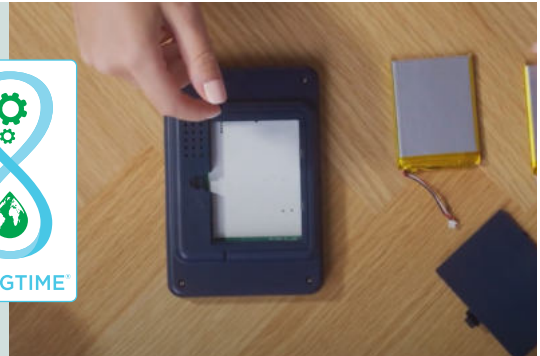

**FRENCH  
DESIGN**

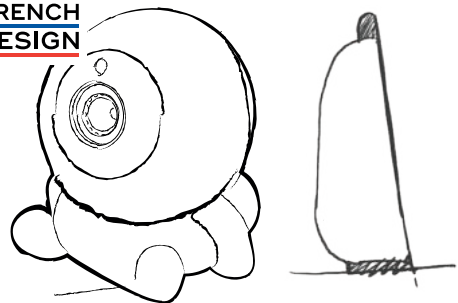

**zzz**  
\_SLEEP  
TECHNOLOGY

DIGITAL GREEN  
TECHNOLOGY

Our commitment doesn't stop there. Babymoov is constantly innovating, equipping its baby monitors with unique and genuinely useful Technologies designed to reduce radio wave emissions, save energy and simplify parents' daily lives.

SKU **A014014**

0 m+



3 661276 148710

**COMPOSITION:**

ABS

**POWER:**  
1,25 mW**FREQUENCY:** 865 MHz**POWER SUPPLY:**

*Baby + Parents Units:* operates with 3 x AAA batteries (not included) or on mains (power adaptor included)

SKU **A014015**

0 m+



3 661276 163355

**COMPOSITION:**

ABS

**POWER:**  
2,99 mW**FREQUENCY:** 865 MHz**POWER SUPPLY:**

*Baby + Parents Units:* operates with 3 x AAA batteries (not included) or on mains (micro-USB cable included)

SKU **A014303**

0 m+



3 661276 163362

**COMPOSITION:**

ABS

**POWER:**  
2,99 mW**FREQUENCY:** 865 MHz**POWER SUPPLY:**

*Parents Unit:* rechargeable lithium battery (USB-C cable included)

*Baby Unit:* operates with 3 x AAA batteries (not included) or on mains (USB-C cable included)



## Simply Care

### Audio babymonitor

THE PERFECT COMBINATION OF SAFETY AND SIMPLICITY

- Range: 300 m
- VOX function (voice activation) for energy saving
- 2 reception channels
- 2 alarms: audible and visual
- Adjustable volume



## Easy Care

### Audio babymonitor

THE EASY-TO-USE MULTI-FUNCTION BABY MONITOR

- « Digital Green Technology »: low waves transmitting power and long range
- Range: 500 m
- VOX function (voice activation) for energy saving
- Automatic channel search
- 2 alarms: audible and visual
- Adjustable volume
- Nightlight
- Belt clip on the parent unit



DIGITAL GREEN TECHNOLOGY



## Expert Care

### Audio babymonitor

THE COMPACT, LONG-RANGE BABYMONITOR

- « Digital Green Technology »: low waves transmitting power and long range
- Range: 1,000 m
- VOX function (voice activation) for energy saving
- Automatic channel search
- 3 alarms: vibrating, audible and visual
- Adjustable volume
- Nightlight
- Belt clip on the parent unit
- Rechargeable lithium battery in the parents unit



DIGITAL GREEN TECHNOLOGY



Top-Seller

SAFETY



# Handy Care

## Audio babymonitor

THE AUDIO BABY MONITOR WITH GREAT AUTONOMY AND EASY TO USE



- « Sleep » technology: does not emit any waves whilst baby sleeps
- Range: 500 m
- VOX function (voice activation) for energy saving
- Automatic channel search
- 2 alarms: audible and visual
- Adjustable microphone volume and sensitivity
- Soft moonlight shape nightlight
- Walkie Talkie function
- Belt clip on the parent unit
- Rechargeable lithium battery in the parents unit

SKU **A014304**

0 m+



3 661276174535

**COMPOSITION:**  
ABS

**POWER:**  
1,25 mW

**FREQUENCY:** 2,4 GHz

**POWER SUPPLY:**

*Parents Unit:* rechargeable lithium battery (Jack-USB cable included)  
*Baby Unit:* operates with 3 x AAA batteries (not included) or on mains (Jack-USB cable included)



“ **Handy Care** is equipped with the « Sleep » technology: a Babymoov innovation that allows the baby monitor to emit no waves as long as the emisor does not detect any noise (when baby is sleeping). ”



**MARIE BEE**

*Babymoov Product Manager*



# Solutions designed for a sleepy life





## Premium Care Audio babymonitor

THE LONG-RANGE, MULTI-FUNCTION BABY MONITOR



DIGITAL GREEN  
TECHNOLOGY

- « Digital Green Technology »: low waves transmitting power and long range
- Range: 1,400 m
- VOX function (voice activation) for energy saving
- Automatic channel search
- 3 alarms: vibrating, audible and visual
- Adjustable volume
- Nightlight and 6 lullabies
- Walkie Talkie function
- Temperature indicator
- Belt clip on the parent unit
- Option to connect up to 2 transmitters
- Rechargeable lithium battery in the parents unit

SKU **AO14204**

0 m+



3 661276 163331

**COMPOSITION:**

ABS

**POWER:**  
2,99 mW

**FREQUENCY:** 865 MHz

**POWER SUPPLY:**

*Parents Unit:* rechargeable lithium battery (USB-C cable included)  
*Baby Unit:* operates with 3 x AAA batteries (not included) or on mains (USB-C cable included)



## Premium Care Additional transmitter



SKU **AO14624**

0 m+



3 661276 163393

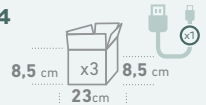

“ The **Premium Care** is equipped with « Digital Green Technology », a Babymoov innovation that reduces the level of wave emissions while guaranteeing the longest ranges on the market. ”



**GUILLAUME BARDALES**  
*Babymoov Quality Manager*



## Audio and Video Babymonitor Accessories



**Power adaptor**  
5V-600mA Micro-USB

SKU **AO14617**



3 661276 016620



**Universal USB plug**  
5V-1000mA

SKU **AO14626**



3 661276 164352





# Essential

## Video babymonitor

THE ESSENTIAL FUNCTIONS TO KEEP AN EYE ON BABY



- Range: 250 m
- 2.4" (5cm) screen: digital quality
- VOX function (voice activation) for energy saving
- 2 alarms: audible and visual
- Adjustable volume
- Night vision, Zoom (x2)
- Wall-mounting kit
- Rechargeable lithium battery in the parents unit

Ref. **AO14415**

0 m+



3 661276 153868

**COMPOSITION:** ABS

**POWER:** 50,11 mW

**FREQUENCY:** 2,4 GHz

**POWER SUPPLY:**

*Parents Unit:* rechargeable lithium battery (power adaptor included)

*Camera:* operates on mains (power adaptor included)





# Yoo-Care

## Video baby monitor

THE VIDEO BABY MONITOR THAT'S SO SIMPLE TO USE



Ref. **AO14422**

0 m+



**COMPOSITION:**  
ABS

**POWER:**  
50,11 mW

**FREQUENCY:** 2,4 GHz

**POWER SUPPLY:**

Camera: operates with 3 x AAA batteries (not included) or on mains (micro-USB cable included)

Parents Unit: rechargeable lithium battery (power adaptor included)

- Range: 300 m
- 2.4" (5cm) screen: digital quality
- VOX function (voice activation) for energy saving
- 2 alarms: audible and visual
- Adjustable volume
- Walkie Talkie function
- Night vision, Zoom (x2)
- Nightlight
- Temperature indicator
- Rechargeable lithium battery in the parents unit

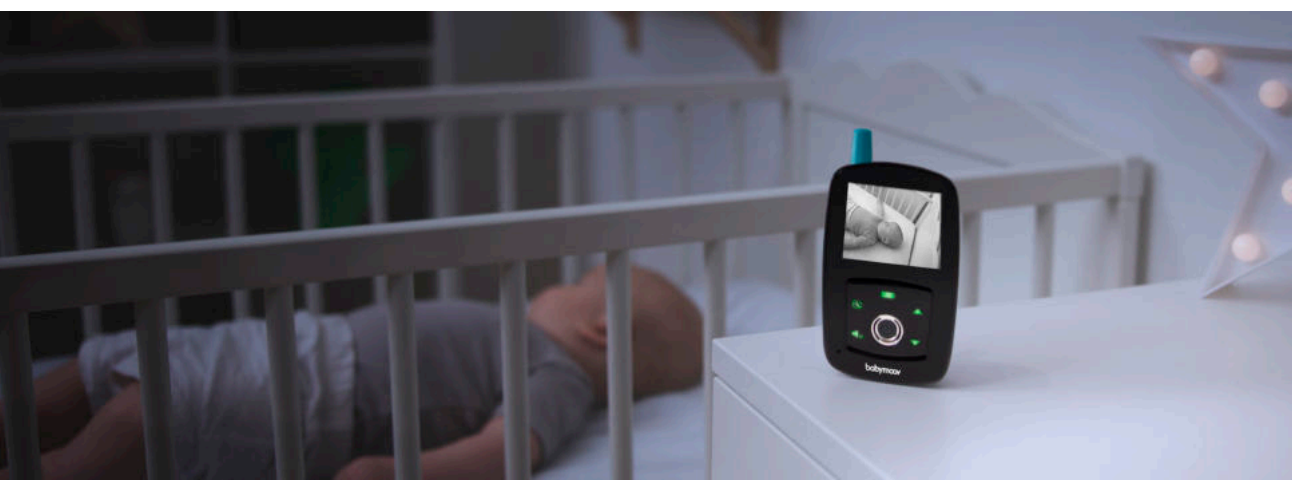

New

# Yoo-Roll

EXPERT

RECHARGEABLE  
BATTERY-  
POWERED  
CAMERA

PREMIUM

UNIQUE  
« SLEEP »  
TECHNOLOGY

DURABLE

REPAIRABLE  
& LIFETIME  
WARRANTY



New

SAFETY



# Yoo-Roll Video babymonitor

THE PORTABLE VIDEO BABY MONITOR WITH RECHARGEABLE BATTERIES



THE YOO  
CONCEPT

- VOX function (voice activation) for energy saving
- Adjustable volume
- Walkie Talkie function
- Night vision, Zoom (x2)
- Option to connect up to 4 transmitters
- Rechargeable lithium battery in the parents unit
- Rechargeable lithium battery in both the parents unit and the camera
- Range: 300 m
- 3.5" (7.6 cm) screen: digital quality
- 3 alarms: vibrating, audible and visual
- « Sleep » technology: does not emit any waves whilst baby sleeps
- 8 gentle lullabies

SKU **AO14431**

0 m+



3 661276 184329

COMPOSITION:  
ABS

POWER:  
50,11 mW

FREQUENCY: 2,4 GHz

POWER SUPPLY:  
Camera + Parents Unit:  
rechargeable lithium battery  
(USB-C cables included)



# Yoo-Roll Extra camera



0 m+

SKU **AO14432**



3 661276 184480



“ 61% of parents use their baby monitor outside their home, which is why we have developed **Yoo-Roll**, the portable baby monitor with rechargeable batteries. ”



**MARIE BEE**

Babymoov Product Manager



New

# Yoo-Go

EXPERT

RECHARGEABLE  
BATTERY-  
POWERED  
CAMERA

~ ~ ~  
4 MOUNTING  
ACCESSORIES

PREMIUM

UNIQUE  
« SLEEP »  
TECHNOLOGY

DURABLE

REPAIRABLE  
& LIFETIME  
WARRANTY



New



## Yoo-Go<sup>(+)</sup> Video babymonitor

THE WIRELESS, LOW EMISSION VIDEO BABYMONITOR WITH 4 ATTACHMENT ACCESSORIES FOR FIXING IT EVERYWHERE



THE YOO  
CONCEPT

- VOX function (voice activation) for energy saving
- Adjustable volume
- Walkie Talkie function
- Night vision, Zoom (x2)
- Option to connect up to 4 transmitters
- Rechargeable lithium battery in the parents unit
- Rechargeable lithium battery in both the parents unit and the camera
- Range: 300 m
- Wide 5" (12.7 cm) screen: digital quality
- 2 alarms: audible and visual
- 4 accessories included (stand, suction cup, bracket, wall-mounting kit)
- « Sleep » technology: does not emit any waves whilst your baby sleeps
- « Split » mode to view all additional cameras at the same time
- 8 gentle lullabies

SKU **AO14429**

O m+



3 661276 182233

COMPOSITION:

ABS

POWER:  
50,11 mW

FREQUENCY: 2,4 GHz

POWER SUPPLY:

Camera + Parents Unit:  
rechargeable lithium battery  
(USB-C cables included)



## Yoo-Go<sup>(+)</sup> Extra camera



SKU **AO14430**

O m+



3 661276 182257



“ For even more nomadic parents, even with a child, **Yoo-Go<sup>(+)</sup>** is the ideal baby monitor to take along and easily install anywhere with its 4 mounting accessories. ”



**MARIE BEE**

*Babymoov Product Manager*



# Solutions designed for a great life



Top-Seller

SAFETY



# Yoo-Twist

## Motorised video baby monitor

A MULTI-PURPOSE BABY MONITOR WITH A STYLISH CAMERA THAT ROTATES AND TILTS THROUGH 360°



THE YOO  
CONCEPT

- VOX function (voice activation) for energy saving
- Adjustable volume
- Walkie Talkie function
- Night vision, Zoom (x2)
- Option to connect up to 4 transmitters
- Rechargeable lithium battery in the parents unit
- Camera controlled from the receiver: 360° tilt and rotation
- Range: 300 m
- 3.5" (7.6 cm) screen: digital quality
- 3 alarms: vibrating, audible and visual
- « Sleep » technology: does not emit any waves whilst baby sleeps
- 8 gentle lullabies
- Temperature indicator

SKU **A014425**

0 m+



3 661276 180277

COMPOSITION:  
ABS

POWER:  
50,11 mW

FREQUENCY: 2,4 GHz

POWER SUPPLY:

Parents Unit: rechargeable lithium battery (USB-C cable included)

Camera: operates on mains (jack-USB cable included)

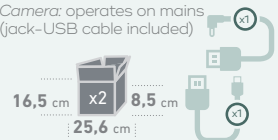

# Yoo-Twist

## Extra motorised camera



0 m+

SKU **A014427**



3 661276 181434



“ With its motorised camera, numerous features and attractive design, the **Yoo-Twist** is ideal for reassuring parents while their baby sleeps. ”



**MARIE BEE**  
Babymoov Product Manager



**Solutions  
designed for  
a peaceful life**





Top-Seller

SAFETY



# Yoo-Master<sup>(+)</sup> Motorised video baby monitor

A MULTI-PURPOSE BABY MONITOR WITH A STYLISH CAMERA THAT ROTATES AND TILTS THROUGH 360° AND A 5" SCREEN



THE YOO  
CONCEPT

- VOX function (voice activation) for energy saving
- Adjustable volume
- Walkie Talkie function
- Night vision, Zoom (x2)
- Option to connect up to 4 transmitters
- Rechargeable lithium battery in the parents unit
- Camera controlled from the receiver: 360° tilt and rotation
- Range: 300 m
- Wide 5" (12.7 cm) screen: digital quality
- 2 alarms: audible and visual
- « Sleep » technology: does not emit any waves whilst your baby sleeps
- « Split » mode to view all additional cameras at the same time
- 8 gentle lullabies
- Temperature indicator

SKU **AO14426**

0 m+



3 661276 180284

COMPOSITION:

ABS

POWER:

50,11 mW

FREQUENCY: 2,4 GHz

POWER SUPPLY:

Parents Unit: rechargeable lithium battery (USB-C cable included)

Camera: operates on mains (jack-USB cable included)



## Yoo-Master<sup>(+)</sup> Extra motorised camera



SKU **AO14428**

0 m+



3 661276 181441



“ With its motorised camera, its large 5" screen and its attractive design, the **Yoo-Master<sup>(+)</sup>** baby monitor is ideal to reassure parents during baby's sleep. ”



**MARIE BEE**  
Babymoov Product  
Manager



# Solutions designed for a serene life



# Yoo-Moov

## Motorised video baby monitor

THE REASSURING 360° MOTORISED BABY MONITOR, TO ALWAYS HAVE AN EYE ON BABY



### THE YOO CONCEPT

- VOX function (voice activation) for energy saving
- Adjustable volume
- Walkie Talkie function
- Night vision, Zoom (x2)
- Option to connect up to 4 transmitters
- Rechargeable lithium battery in the parents unit
- Camera controlled from the receiver: 360° tilt and rotation
- Range: 300 m
- Wide 4.3" (11 cm) screen: digital quality
- 2 alarms: audible and visual
- Nightlight with 7 colours
- 5 gentle lullabies
- Temperature indicator
- Wall-mounting kit

SKU **AO14417**

0 m+



3 661276 155633

#### COMPOSITION:

ABS

#### POWER:

50,11 mW

FREQUENCY: 2,4 GHz

#### POWER SUPPLY:

Parents Unit: rechargeable lithium battery (jack-USB cable included)

Camera: operates on mains (jack-USB cable included)



# Yoo-Moov

## Extra motorised camera



SKU **AO14418**

0 m+



3 661276 155640



“ The **Yoo-Moov** is aimed at parents looking for innovation, simplicity and performance so they can enjoy every moment of their baby's life. ”



**CÉLIA GRIGNON**

Babymoov General Manager  
of Innovation & Marketing





**Solutions  
designed for  
a safe life**



	Simply Care	Easy Care	Expert Care	Handy Care	Premium Care	Essential	Yoo-Roll	Yoo-Go <sup>(s)</sup>	Yoo-Twist	Yoo-Master <sup>(+)</sup>	Yoo-Moov
	AO14014	AO14015	AO14303	AO14304	AO14204	AO14415	AO14431	AO14424	AO14425	AO14426	AO14417
Technology	AUDIO					VIDEO			MOTORISED VIDEO		
Range	300 m.	500 m.	1 000 m.	500 m.	1 400 m.	250 m.	300 m.	300 m.	300 m.	300 m.	300 m.
Screen size						2,4"	3,5"	5"	3,5"	5"	4,3"
Number of connectable transmitter					x2		x4	x4	x4	x4	x4
<b>FUNCTIONS</b>											
VOX	●	●	●	●	●	●	●	●	●	●	●
« Sleep »				●			●	●	●	●	
Walkie-Talkie				●	●		●	●	●	●	●
Nightlight		●	●	●	●						●
Lullabies					●		●	●	●	●	●
Temperature indicator					●				●	●	●
Night vision						●	●	●	●	●	●
Zoom						x2	x2	x2	x2	x2	x2
Alarm (visual & audio)	●	●	●	●	●	●	●	●	●	●	●
Vibration alarm			●		●		●		●		
Adjustable volume	●	●	●	●	●	●	●	●	●	●	●
<b>HANGING</b>											
Wall-mounting kit						●		●			●
Suction cup								●			
Bracket								●			
Belt clip (Receiver)	●	●	●	●	●						
<b>POWER SUPPLY</b>											
<b>PARENTS UNIT</b>											
Batteries*	3 x AAA	3 x AAA									
Battery											
Main											
<b>BABY UNIT</b>											
Batteries*	3 x AAA	3 x AAA	3 x AAA	3 x AAA	3 x AAA						
Battery											
Main											

\* batteries not included





# Care range



Grooming sets / changing mats /  
bathtubs

# Babymoov, solutions designed for a great life.

A babycare kit, a travel changing mat, an inflatable and adaptable baby bath... these essentials are for parents who are increasingly **ON THE MOOV**, but don't want to neglect baby's comfort when it's time for a nappy change and a little love and attention.



Convenience, adaptability, compactness, choice of materials... we've left nothing to chance to ensure that bathtime and grooming are always times of togetherness.



## Grooming set

THE ESSENTIAL KIT THAT CARES FOR BABY AS WELL AS THE PLANET

wood



### 10 ESSENTIAL ACCESSORIES FOR CARING FOR BABY:

- Digital thermometer with soft tip
- Baby nasal aspirator (with separate collection chamber)
- Nail clippers
- Rounded-tip scissors
- Nail file
- Bath thermometer
- Chillable teething ring
- Baby toothbrush
- Soft brush made from FSC® wood and goat hair
- 3 reusable cotton wipes

- Compact and lightweight
- Handle for carrying or hanging
- Elastic straps and mesh pockets for organising the accessories easily
- Made from recycled Polyester

Matcha

SKU **A032007**

0 m+



3 661276 177895

#### COMPOSITION:

Case: 100% Polyester  
Brush: Wood, goat hair  
Wipes: 100% Cotton

#### MAINTENANCE:

Case: surface washable with a damp cloth  
Wipes: machine washable at 30°C

#### PRODUCT SIZE (W X D X H):

Closed: 22 x 18,5 x 5 cm

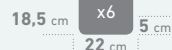

## Grooming set

THE ESSENTIAL BABY CARE KIT

### 9 ESSENTIAL CARING ACCESSORIES:

- Digital thermometer with soft tip
- Baby nasal aspirator (with separate collection chamber)
- Rounded-tip scissors
- Nail trimmers
- Nail file
- Bath thermometer
- Soft brush
- Chillable teething ring
- Baby toothbrush

- Compact and lightweight
- Large handle for carrying or hanging
- Elastics and pockets to organise the accessories easily



0 m+

#### COMPOSITION:

100% Polyester

#### MAINTENANCE:

Surface washable with a damp cloth

#### SIZE PRODUCT (L x h):

Closed: 22 x 18,5 x 5 cm



Aqua

SKU **A032002**



3 661276 143173

Peach

SKU **A032004**



3 661276 154322



## NomadCare

### Travel changing mat

THE ONLY CHANGING MAT THAT IS SUITABLE FOR ANY SURFACE

- **Comfortable:** contains microbeads, making it suitable for any surface, designed to cushion any lumps or bumps that would be uncomfortable for baby, in the car or out and about
- **Waterproof:** to liquids and damp surfaces, so the baby will always be nice and dry
- **Compact:** can be folded up, making it compact enough inside its changing pouch to pop inside any bag
- **Portable:** its strap is ideal for carrying and hanging up wherever
- **Practical:** mesh pocket to keep all baby's accessories within easy reach

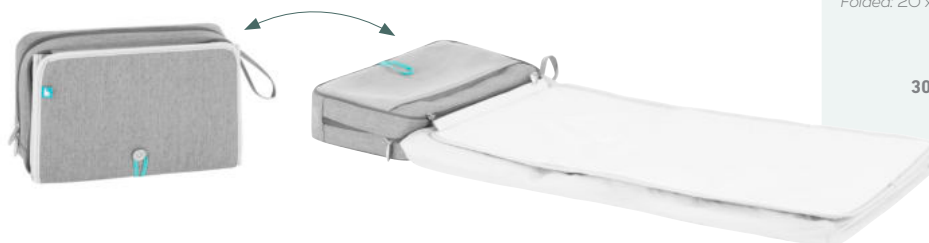

## Adaptable Inflatable bathtub

THE 2-IN-1 SPACE-SAVING BATHTUB AND PADDLING POOL

- **2-in-1:** inflatable bathtub and bath seat (can be used together or separately)
- Suitable from birth, thanks to its inflatable and removable bath seat
- **Comfortable:** inflatable bath seat and bottom
- **Safe:** air check valve, does not deflate
- **Easy to use:** drain plug at bottom of bathtub
- **Compact,** easy to store and to transport, can be used anywhere inside or outside



SKU **A024003**

O m+

3 661276 170049

**COMPOSITION:**  
Changing mat + bag: 100% Polyester  
Interior: 100% EVA  
Mattress: 90% Polyester, 10% Cotton  
Filling: 100% Polystyrene microbeads  
Mattress cover: 100% Nylon

**MAINTENANCE:**  
Changing mat + bag: hand-washable  
Mattress cover: machine-washable at 30°C

**PRODUCT SIZE (W x D x H):**  
Unfolded: 35 x 81 x 6 cm  
Folded: 20 x 11 x 32 cm

**Aqua Dots**

SKU **A019410**

O m+

3 661276 175259

**COMPOSITION:**  
PVC

**PRODUCT SIZE (W x D x H):**  
80 x 52 x 21 cm





# Out & About range



Summer protection / travel cots /  
changing bags / baby carriers

# Babymoov, solutions designed for an active life.

Our outdoor range is expanding to offer innovative and ingenious solutions for families who are increasingly on the move... on a night out with friends, a weekend with grandparents, a trip to the seaside or a holiday abroad. Babymoov makes getting around with the family easy.



**Camille RIEU**  
FrenchPhysiotherapist,  
co-creator of the Moov  
& Boost

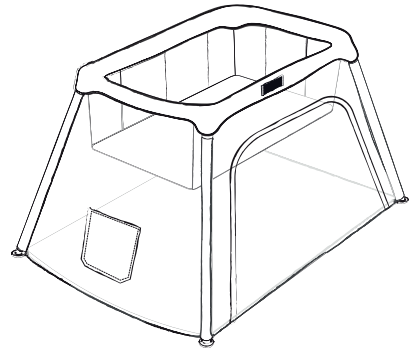

UV protection co-created with experts – you can count on us to look after your baby when you're out and about.



Our range of changing bags is a must for parents who want to get out and about but without all the hassle, and keep the essentials close at hand, wherever they are, at any time. There's no compromise between design and practicality.





**Solutions  
designed for  
a safe life**

# Babyni

## 2-in-1 play area

TO PROTECT BABY COMFORTABLY, FROM UV RAYS, WIND AND SAND



- High UPF 50+ anti-UV protection
- 2-in-1: play area and travel cot
- Foldable fine mesh mosquito net
- Pop-up system for easy folding and unfolding
- Foldable canopy for indoor use
- Comfortable padded mattress included, for baby's naps
- Storage bag with shoulder strap included

**Marinière**  
SKU **A035219**

0 m+  
< 9 kg



3 661276 173620

**COMPOSITION:**  
100% Polyester

**MAINTENANCE:**  
Wipeable with damp cloth

**PRODUCT SIZE (W x D x H):**  
Unfolded: 72 x 84 x 50 cm  
Folded: ø40 cm



“ The **Babyni** is versatile, so it can be used both outdoors (beach, park, mountains...) and indoors. With its high protection (UPF 50+), it blocks up to 99% of harmful rays (UVA and UVB). ”



**PRESCILLA CONNAN**  
*Babymoov Product Manager*



# Anti-UV tent

TO PROTECT BABY AT THE BEACH OR IN THE PARK



- Protects from the sun's ray, wind, sand and insects
- High UPF 50+ anti-UV protection
- Mosquito net with Velcro fastening
- Pop-up system for easy folding and unfolding
- 1 window for better ventilation
- Water-repellent fabric and floor
- Lightweight (<1kg)
- 4 pegs included
- Storage bag with large handle strap included

**Blue Waves**  
SKU **A038216**

0 m+



**COMPOSITION:**  
100% Polyester

**MAINTENANCE:**  
Wipeable with damp cloth

**PRODUCT SIZE (W x D x H):**  
Unfolded: 98 x 89 x 90 cm  
Folded: ø60 cm



“ The **anti-UV** tent has quickly become a parent's must-have, offering optimal protection from the sun's rays as well as from wind, sand and insects. It stops up to 99% of the sun's harmful rays (UVA and UVB) thanks to its high UPF 50+ protection. ”



**PRESCILLA CONNAN**  
Babymoov Product Manager



## Anti-UV tent

TO PROTECT BABY AT THE BEACH OR IN THE PARK

New colour



**Marinière**  
SKU **A038215**  
  
3 661276171466



**Provence**  
SKU **A038218**  
  
3 661276 184428



- Protects from the sun's ray, wind, sand and insects
- High UPF 50+ anti-UV protection
- Fine mesh mosquito net with full zip fastening
- Pop-up system for easy folding and unfolding
- 2 windows with flaps for better ventilation
- Water-repellent fabric and floor
- Lightweight (<1kg)
- 3 pegs included
- Storage bag with large shoulder strap included

0 m+

**COMPOSITION:**  
100% Polyester

**MAINTENANCE:**  
Wipeable with damp cloth

**PRODUCT SIZE (W x D x H):**  
Unfolded: 100 x 100 x 80 cm  
Folded: ø60 cm



# Solutions designed for a curious life





# Aquani

## 3-in-1 play area

TO PROTECT, ENTERTAIN AND REFRESH BABY



**Marinière**

SKU **AO35220**



3 661276 175648



New color

**Provence**

SKU **AO35221**



3 661276 184435



- High UPF 50+ anti-UV protection
- 3-in-1: play area, travel cot and small padding pool
- Foldable mosquito net
- Pop-up system for easy folding and unfolding
- Waterproof fabric to use as a paddling pool (75 L)
- Foldable canopy for indoor use
- 2 removable toys with attachments at different heights
- Comfortable, removable play mat (2 built-in toys)
- 4 pegs included
- Storage bag with shoulder strap included

0 m+

**COMPOSITION:**  
100% Polyester

**MAINTENANCE:**  
Wipeable with damp cloth  
Mattress Hand-washable

**PRODUCT SIZE (W x D x H):**  
Unfolded: 92 x 92 x 60 cm  
Folded: ø60 cm



“ The **Aquani** is a real 3-in-1 for a safe and comfortable play area for families on the go. It protects baby from the sun’s rays thanks to its high UPF 50+ protection, as well as from wind, sand and insects. Its added bonus: its waterproof fabric that allows it to be filled with water. ”



**CHARLINE SPEZIALE**  
Babymoov Product Marketing  
Manager



New

# Moov & Comfy

EXPERT

**3-IN-1:  
CRADLE,  
TRAVEL COT AND  
PLAY PEN**

PREMIUM

**2 MATTRESSES,  
EACH 2.5 CM  
THICK AND WITH  
A DENSITY OF  
25 KG/M<sup>3</sup>**

DURABLE

**LIFETIME  
WARRANTY**



New

OUT & ABOUT



# Moov & Comfy Travel cot

THE COMFORTABLE COT FROM BIRTH TO 4 YEARS



- 3-in-1: cradle (up to 9 kg), travel cot and play pen
- Comfortable: 2 mattresses of 2.5 cm thickness and 25 kg/m<sup>3</sup> density
- Suitable from birth: built-in raised cradle making it easier to lay baby down and pick them up
- Evolutive, up to 4 years thanks to its large mattress (120 x 75 cm) fixed to the bed and removable
- Wide side opening for easy access in and out, or for converting the cot into a play pen
- Removable structure, made of mesh to ensure good ventilation
- Stable feet
- Side pocket to store a dummy or baby monitor
- Easy to unfold, install and fold
- Carry bag included

SKU **A035032**

O-4 Y



3 661276 179462

**COMPOSITION:**

100% Polyester  
Foam: 100% Polyurethane

**MAINTENANCE:**

Removable structure,  
mattress covers are machine  
washable at 30°C

**PRODUCT SIZE (W x D x H):**

Opened: 120 x 78 x 72 cm  
Folded: 90 x 14 x 58 cm



“**Moov & Comfy** is the ideal travel cot: a raised cradle for the first 6 months of baby's life and a large travel bed for later. Parents will be well equipped for outings with their child, who can play and sleep comfortably.”



**DOMITILLE BARDET**  
Babymoov Product Manager



New

# Moov & Sleep



BLACK



PANTONE  
7590 C

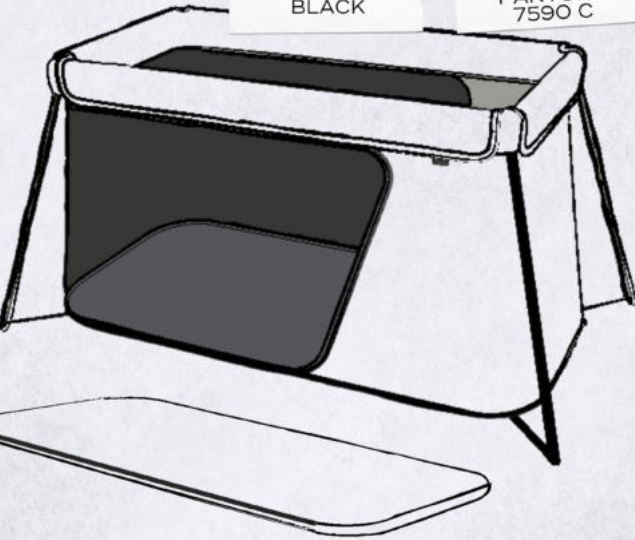

EXPERT

ULTRA  
COMPACT

PREMIUM

ULTRA-  
COMFORTABLE  
MATTRESS



DURABLE

LIFETIME  
WARRANTY

New

OUT & ABOUT



# Moov & Sleep

## Travel cot

THE ULTRA-LIGHTWEIGHT AND COMPACT TRAVEL COT FOR UNRESTRICTED MOBILITY

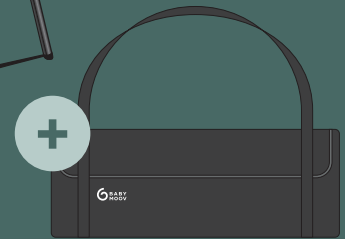
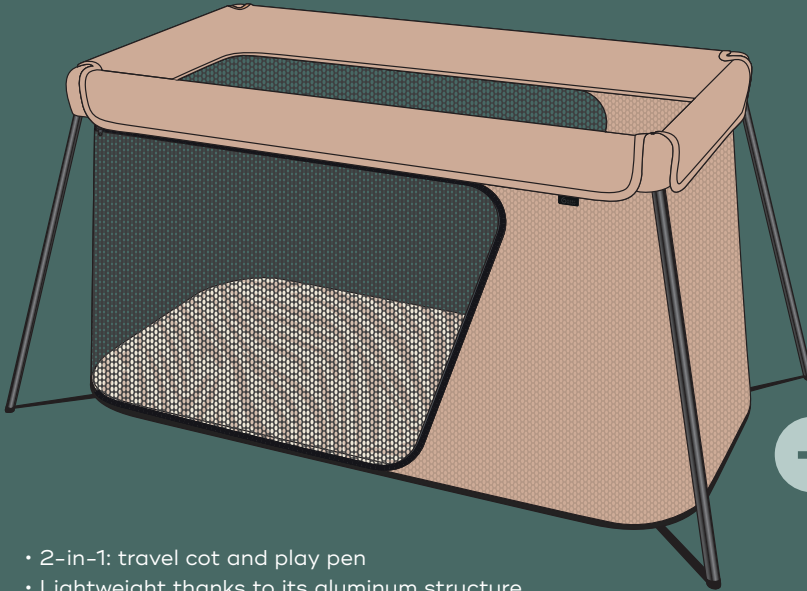

- 2-in-1: travel cot and play pen
- Lightweight thanks to its aluminum structure
- Ultra-compact
- Ingenious ultra-foldable system
- Easy to unfold, install and fold
- Comfortable: mattress of 2.5 cm thickness and 25 kg/m<sup>3</sup> density
- Suitable from birth and adaptable up to 4 years thanks to its large mattress (120 x 60 cm) attached to the crib and removable
- Opaque side for night and breathable mesh side for daytime
- Wide opening for easy access in and out, or for converting the cot into a play pen
- Removable structure, made of mesh to ensure good ventilation
- Stable feet
- Side pocket to store a dummy or baby monitor
- Ultra-convenient carry bag: can be worn over the shoulder or as a backpack

SKU **A035033**

O-4 Y



3 661276 185425

**COMPOSITION:**

100% Polyester  
Foam: 100% Polyurethane

**MAINTENANCE:**

Removable structure,  
mattress cover is machine  
washable at 30°C

**PRODUCT SIZE (W x D x H):**

Opened: 135 x 70 x 65  
Folded: ø23 x 70 cm



“ Compact and ultra-lightweight, the **Moov & Sleep** travel cot can be taken anywhere and carried on the shoulder or as a backpack. Very easy to set up, it unfolds and folds back in less than a minute. ”



**CHARLINE SPEZIALE**

*Babymoov Product Marketing  
Manager*

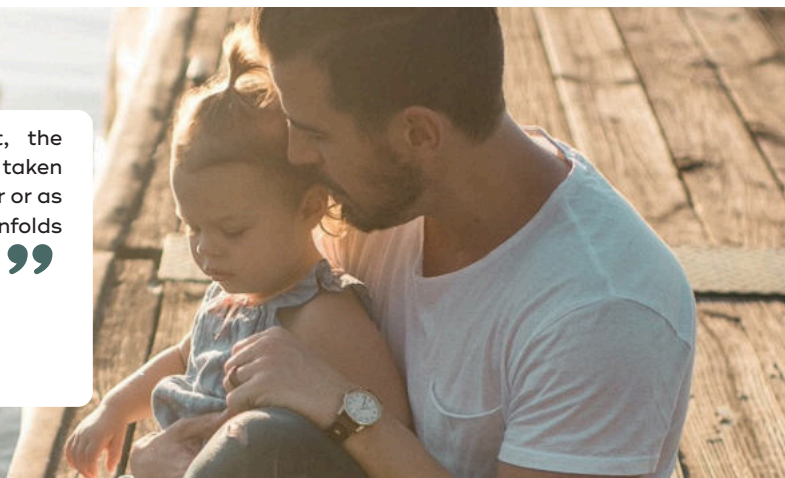

# Babymoov, solutions designed for a trendy life.

## Every parent has a changing bag.

But everyone has their own preferences in terms of size, style, number of pockets, etc.

At Babymoov, we understand this very well!  
That's why we have designed a new offer that evolves over time based on trends, seasons, desires, co-creations, aiming to be sustainable, distinctive, and most importantly, with real added value.

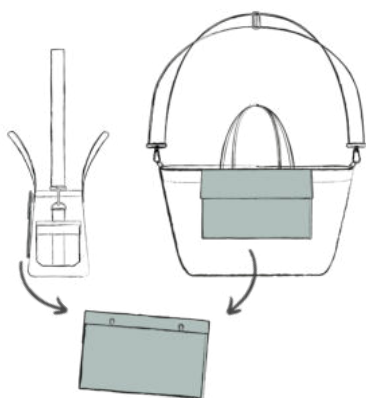

In this brand new range of Babymoov (changing) bags, we offer 2 timeless bases, to which removable pockets can be attached, providing that trendy extra touch. These pockets not only add extra capacity but also, and above all, a unique style so that everyone can create their own! They can be carried by hand, attached to the bag, or worn directly over the shoulder thanks to the shoulder strap.

## The new collection of Babymoov changing bags is for:

Those who want a practical and functional bag thanks to the timeless **Day to Day Bag**.

Those who want style over function with the iconic **Tote Bag**.



**Our concept is based on 2 essential criteria for parents: practicality and design.**



**Solutions**  
**designed for**  
**a beautiful life**

New

# Day to Day Bag



PANTONE 7545 C



PANTONE 4219 C



EXPERT

OPTIMIZED  
SHAPE  
FOR EVERYDAY  
CAPACITY

PREMIUM

2-IN-1  
THANKS TO  
THE POCKET

DURABLE

RECYCLED  
AND STURDY  
FABRICS





New

OUT & ABOUT

# Day to Day Bag

## Changing bag

THE CHANGING BAG WITH ESSENTIAL FUNCTIONS THAT IS INSPIRED BY FASHION CODES



- Capacity: 23 litres
- Optimized shape to save space
- Numerous interior and exterior pockets
- Can be carried by hand, on the shoulder (double handles), or crossbody
- Rigid base for perfect support
- Accessories included: 2 stroller clips, 1 dummy pouch, 1 insulated pouch, 1 detachable waterproof changing mat and 1 suitcase strap
- Durable fabrics: recycled cotton canvas, long lifespan
- Removable front pocket (3 litres capacity), can be worn alone or with the bag, crossbody or by hand

**COMPOSITION:**

100% Cotton

**MAINTENANCE:**

Bag machine washable at 30°C (delicate cycle), accessories washable by hand

**PRODUCT SIZE (W x D x H):**

40 x 19,5 x 28 cm



“ The **Day to Day Bag** changing bag adapts to new trends thanks to its removable pocket and its design that changes with the seasons. It's practical for everyday outings thanks to its optimised size and the 6 accessories included. ”



**MARIE BEE**

*Babymoov Product Manager*



New

# Tote Bag



EXPERT

LARGE  
CAPACITY

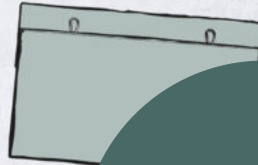
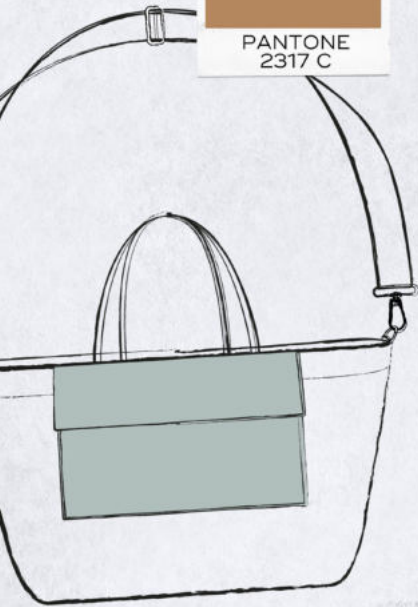

PREMIUM

FINEST  
MATERIALS  
AND TRENDY  
STYLE



DURABLE

ZERO  
WASTE FABRIC  
PATTERNING



# Tote Bag

## Changing bag

A MUST-HAVE FOR WOMEN WHO WANT TO MAINTAIN THEIR STYLE EVEN WHEN THEY GO OUT WITH THEIR BABY



### Bloom

SKU **AO43812**



3 661276 180291



### Fancy

SKU **AO43813**



3 661276 180307



### Sherpa

SKU **AO43814**



3 661276 180314



### Zebra

SKU **AO43815**



3 661276 183391



- Adjustable capacity: from 35 to 40 litres (with gusset)
- Can be carried by hand, on the shoulder (double handles), or crossbody
- Rigid base for perfect support
- Accessories included: 2 stroller clips and 1 detachable waterproof changing mat
- Durable fabrics: recycled cotton canvas, long lifespan
- Removable front pocket (3 litres capacity), can be worn alone or with the bag, crossbody or by hand
- Zero waste pattern, does not create fabric waste

#### COMPOSITION:

Bag: 100% Cotton

Pocket:

AO43812, AO43815: 100% Cotton

AO43813: 76% Chlorofiber, 22%

Polyester, 2% Polyurethane

AO43814: 100% Polyester

#### MAINTENANCE:

Bag machine washable at 30°C

(delicate cycle), accessories

washable by hand

#### PRODUCT SIZE (W x D x H):

60 x 18 x 34 cm



“ The **Tote Bag** changing bag adapts to new trends thanks to its removable pocket and its simple, iconic and timeless shape. It's practical and stylish, thanks to its adjustable size and modern, trendy fabrics, patterns and materials. ”



**MARIE BEE**

*Babymoov Product Manager*



# Le Champs-Élysées

## Changing bag

### THE AMBASSADOR OF FRENCH ELEGANCE

- Large capacity: 29 litres
- Modular compartment system inside the bag
- Several inner pockets: zipped pocket and elasticated pockets
- Wide opening with double zip pull
- Can be carried on the shoulder or cross-body
- Rigid base for perfect support
- Can slide onto the telescopic handle of a suitcase
- Premium accessories included: 2 stroller clips, 1 dummy pouch, 1 insulated pouch, 1 tassel key ring, 1 detachable waterproof changing mat and 1 embroidered terry towel
- Water-repellent fabric

**COMPOSITION:**

Exterior: 100% Polyurethane -  
Lining & back: 100% Polyester  
Insulated cover: Polyester, PET  
Changing mat: Polyester, PEVA  
Dummy pouch: Polyester, PEVA  
Towel: 85% Cotton, 15% Polyester

**MAINTENANCE:**

Bag and accessories hand-washable, towel machine washable at 60°C

**PRODUCT SIZE (W x D x H):**

53 x 19 x 24 cm



**Mineral Blue**

SKU **AO43805**



3 661276 163836



**Saffron**

SKU **AO43806**



3 661276 163843



## Le Pyla

### Changing backpack

#### THE PRACTICAL AND ACCESSIBLE BACKPACK CHANGING BAG

- Capacity: 17 litres
- Large 180° opening, easy to fill and easy access to all the belongings
- Several inside pockets including one zipped pocket for the parent's belongings
- Stretchy pocket on the outside
- Large insulated pocket accessible via the front of the bag
- Ingenious slots to be slid onto a telescopic suitcase handle, or can to store the straps
- Accessories included: 2 stroller clips and 1 detachable waterproof changing mat
- Comfortable: padded back and straps
- Water-repellent fabric

#### COMPOSITION:

Exterior and lining:  
100% Polyester - Coating:  
100% PVC - Filling: 100%  
Polyethylene  
Insulated pocket: PET, PEVA -  
Changing mat: Polyester, PVC,  
PEVA

#### MAINTENANCE:

Bag and accessories hand-  
washable

#### PRODUCT SIZE (W x D x H):

34 x 10,5 x 41,5 cm



## Le Sancy

### Changing backpack

#### THE ERGONOMIC, EXTENDABLE BACPKACK CHANGING BAG

- Adjustable capacity from 26 to 36 litres
- Pocket for changing supplies at the front
- Large insulated compartment at the back
- Elasticated straps for water bottle on the side of the bag
- Several inner storage compartments (zipped, mesh and elasticated pockets)
- Wide and fully zipped opening
- Comfortable: padded back and straps
- Premium accessories included: 2 stroller clips, 1 dummy pouch, 1 key ring, 1 detachable waterproof changing mat and 1 embroidered terry towel
- Water-repellent fabric

#### COMPOSITION:

*Smokey-AO43801:*

100% Polyester

*Mineral Blue-AO43802:*

Exterior: 100% Polyurethane

Lining & back: 100% Polyester

Insulated cover: Polyester, PET

Changing mat: Polyester, PEVA

Dummy pouch: Polyester, PEVA

Towel: 85% Cotton,

15% Polyester

#### MAINTENANCE:

Bag and accessories hand-  
washable

#### PRODUCT SIZE (W x D x H):

34 x 19 x 39 cm



# Solutions designed for a moving life



# Moov & Boost

## Evolutive baby carrier

FOR EVERYDAY ADVENTURES WITH MINIMUM EQUIPMENT



BREVET  
DÉPOSÉ  
PATENT  
PENDING



**Hazelnut Beige**

SKU **A057005**



3 661276 179288



**Sage Green**

SKU **A057006**



3 661276 179295



CONFIDENCE IN TEXTILES

- Patented and co-created with a French physiotherapist, Camille Rieu
- 2-in-1: converts into a booster seat using an ingenious system of detachable straps and an inflatable cushion
- Ingenious A-line shape, designed to grow with your baby
- Keeps baby's back in a rounded shape
- Guarantees the optimal « frog »\* position for baby
- Easy to use, coloured clips and just 3 straps
- Padded straps and a specific design for comfort on the shoulder blades
- Compact and converts into a bag for easy carrying
- Outer pockets and zipped pocket on the waist belt
- Hood providing protection from UV rays and rain
- Clip for hanging a pocket or tote bag on the shoulder
- Silicone teething ring located on a level with the child's head
- Made from organic cotton canvas and recycled materials
- Water-repellent fabrics
- Newborn insert sold separately (from 3 to 5 kg)

0 m+  
< 15 kg

#### COMPOSITION:

Main fabric: 100% organic Cotton  
Mesh: 100% recycled Polyester  
Suedette: 100% Polyester  
Foam: 100% Polyurethane  
Booster seat lining: 100% recycled Polyester

#### MAINTENANCE:

Machine washable at 30°C (except for the inflatable cushion and teething ring)

#### PRODUCT SIZE (W x D x H):

60 x 45 cm

Folded: 45 x 15 x 5 cm



\*Rated « hip-healthy » by the International Hip Dysplasia Institute

New

## Moov & Boost Newborn insert



0 m+  
3-5 kg

SKU **A057100**



3 661276 182332

#### COMPOSITION:

Fastener: Cotton  
Pillow: Polyester  
Foam: Polyurethane



“ We have created **Moov & Boost** to become the most practical baby carrier ever: an ergonomic baby carrier that converts into a booster seat. There is no compromise on comfort, health and safety. ”



**CAMILLE RIEU**

French Physiotherapist &  
co-creator of the Moov & Boost



## 2-in-1 Walker

INTERACTIVE COMPACT BABY WALKER AND PUSH TOY

- 2-in-1: walker (up to 12 kg) and push toy (up to 24 months)
- Baby's learning companion (walking, musical awareness, agility, etc.)
- Comfortable cushioned seat
- Height-adjustable to 3 positions
- Activity tray with three toys and music box with 3 tunes
- Four wheels (2 steerable) with brakes for greater safety
- Ultra-compact folding



SKU **A040006**

9 m+



**COMPOSITION:**

100% Polypropylene  
Cover: 100% Polyester

**MAINTENANCE:**

Wipeable with damp cloth

**POWER SUPPLY:**

Operates with 2 x AA batteries (not included)



## 5-in-1 Walker

PROGRESSIVE MUSIC AND LIGHTS BABY WALKER/PUSH TOY WITH 360 DEGREE SEAT

- 5-in-1: walker (up to 12 kg), push toy (up to 24 months), swing, 360° seat and play area
- Baby's learning companion (walking, musical awareness, agility, etc.)
- Comfortable cushioned pivoting seat
- Height-adjustable to 3 positions
- 360° electronic (sounds and lights) activity console
- Four wheels (2 steerable) with brakes for greater safety
- Ultra-compact folding



SKU **A040008**

9 m+



**COMPOSITION:**

100% Polypropylene  
Cover: 100% Polyester

**MAINTENANCE:**

Wipeable with damp cloth

**POWER SUPPLY:**

Operates with 2 x AA batteries (not included)







**Solutions  
designed for  
a loving life**



**Solutions designed for life**



# Contact



**Najate KHALFOUNI**  
*Export Area Manager*  
nkhalfouni@babymoov.com

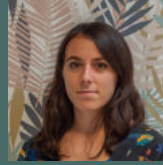

**Zoé GUERIN**  
*International Assistant*  
zguer@babymoov.com



**Yves MARTINS**  
*International Sales &  
Operations Coordinator*  
ymartins@babymoov.com



**Anthony ROSSI**  
*International Marketing  
Coordinator*  
arossi@babymoov.com



**the BABYMOOV team**

# I'm just a catalogue today, but tomorrow I could be your baby's birth announcement (or even your cereal box).



This catalogue is made from PEFC-certified paper from sustainably managed forests.

It was printed by the Imprim'vert-certified Decombat printers.

Remove the rings before recycling it.

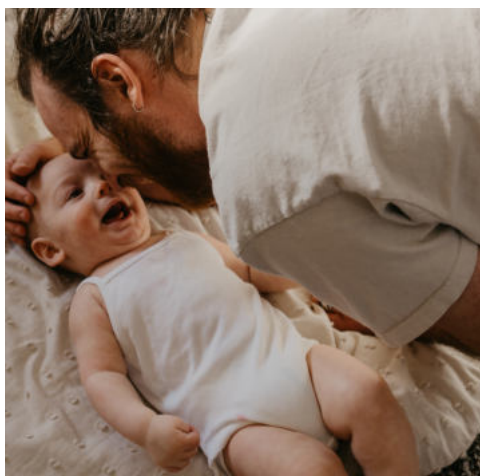

## BABYMOOV GROUP

SAS 109 440 euros  
RCS Clermont-Ferrand N°413 027 129



16 rue Jacqueline Auriol  
Parc Industriel des Granvanches  
63000 Clermont-Ferrand  
FRANCE

 **BABY  
MOOV**  
[www.babymoov.com](http://www.babymoov.com)



PRINT: DECOMBAT

©PHOTOS: RIOT HOUSE PRODUCTION, F. BERRUÉ

